



# ARROYO CENTER

- CHILDREN AND FAMILIES
- EDUCATION AND THE ARTS
- ENERGY AND ENVIRONMENT
- HEALTH AND HEALTH CARE
- INFRASTRUCTURE AND TRANSPORTATION
- INTERNATIONAL AFFAIRS
- LAW AND BUSINESS
- NATIONAL SECURITY
- POPULATION AND AGING
- PUBLIC SAFETY
- SCIENCE AND TECHNOLOGY
- TERRORISM AND HOMELAND SECURITY

The RAND Corporation is a nonprofit institution that helps improve policy and decisionmaking through research and analysis.

This electronic document was made available from [www.rand.org](http://www.rand.org) as a public service of the RAND Corporation.

Skip all front matter: [Jump to Page 1](#) ▼

## Support RAND

- [Purchase this document](#)
- [Browse Reports & Bookstore](#)
- [Make a charitable contribution](#)

## For More Information

- Visit RAND at [www.rand.org](http://www.rand.org)
- Explore the [RAND Arroyo Center](#)
- View [document details](#)

## Limited Electronic Distribution Rights

This document and trademark(s) contained herein are protected by law as indicated in a notice appearing later in this work. This electronic representation of RAND intellectual property is provided for non-commercial use only. Unauthorized posting of RAND electronic documents to a non-RAND website is prohibited. RAND electronic documents are protected under copyright law. Permission is required from RAND to reproduce, or reuse in another form, any of our research documents for commercial use. For information on reprint and linking permissions, please see [RAND Permissions](#).

This report is part of the RAND Corporation research report series. RAND reports present research findings and objective analysis that address the challenges facing the public and private sectors. All RAND reports undergo rigorous peer review to ensure high standards for research quality and objectivity.



# The 2008 Battle of Sadr City

Reimagining Urban Combat

David E. Johnson, M. Wade Markel, Brian Shannon



RAND ARROYO CENTER

# The 2008 Battle of Sadr City

Reimagining Urban Combat

David E. Johnson, M. Wade Markel, Brian Shannon

The research described in this report was sponsored by the United States Army under Contract No. W74V8H-06-C-0001.

#### Library of Congress Cataloging-in-Publication Data

Johnson, David E. (David Eugene), 1950-

The 2008 battle of Sadr City : reimagining urban combat / David E. Johnson, M. Wade Markel, Brian Shannon.

pages cm

Includes bibliographical references.

ISBN 978-0-8330-8028-8 (pbk. : alk. paper)

1. Sadr City, Battle of, Baghdad, Iraq, 2008. 2. Iraq War, 2003-2011—Campaigns—Iraq—Baghdad. 3. Iraq War, 2003-2011—Urban warfare. 4. Counterinsurgency—Iraq—Baghdad. I. Markel, M. Wade. II. Shannon, Brian. III. Title.

DS79.764.B35J643 2013

956.7044'34—dc23

2013048090

The RAND Corporation is a nonprofit institution that helps improve policy and decisionmaking through research and analysis. RAND's publications do not necessarily reflect the opinions of its research clients and sponsors.

Support RAND—make a tax-deductible charitable contribution at [www.rand.org/giving/contribute.html](http://www.rand.org/giving/contribute.html)

**RAND**® is a registered trademark.

© Copyright 2013 RAND Corporation

This document and trademark(s) contained herein are protected by law. This representation of RAND intellectual property is provided for noncommercial use only. Unauthorized posting of RAND documents to a non-RAND website is prohibited. RAND documents are protected under copyright law. Permission is given to duplicate this document for personal use only, as long as it is unaltered and complete. Permission is required from RAND to reproduce, or reuse in another form, any of our research documents for commercial use. For information on reprint and linking permissions, please see the RAND permissions page ([www.rand.org/pubs/permissions.html](http://www.rand.org/pubs/permissions.html)).

RAND OFFICES

SANTA MONICA, CA • WASHINGTON, DC

PITTSBURGH, PA • NEW ORLEANS, LA • JACKSON, MS • BOSTON, MA

DOHA, QA • CAMBRIDGE, UK • BRUSSELS, BE

[www.rand.org](http://www.rand.org)

## Preface

---

This monograph was written as part of a project that assessed U.S. military operations in Sadr City, principally in spring and early summer 2008, to stop Shiite extremists from firing short-range rockets and mortars into the International Zone. These operations also set the conditions to allow stability and Iraqi government control to be extended to the whole of Baghdad. This study of the Battle of Sadr City offers insights and lessons learned that can inform a broader understanding of urban operations—particularly those conducted as part of irregular warfare—and thereby help the Army understand what capabilities it will need in the future.

This research was sponsored by the Office of the Deputy Chief of Staff, G-8, Headquarters, Department of the Army, and is being conducted in RAND Arroyo Center's Strategy, Doctrine, and Resources Program. RAND Arroyo Center, part of the RAND Corporation, is a federally funded research and development center sponsored by the United States Army.

The Project Unique Identification Code (PUIC) for the project that produced this document is ASPMO09462.

Questions and comments regarding this research are welcome and should be directed to the leader of the research team, David E. Johnson, at [davidj@rand.org](mailto:davidj@rand.org).

For more information on RAND Arroyo Center, contact the Director of Operations (telephone 310-393-0411, extension 6419; FAX 310-451-6952; email Marcy\_Agmon@rand.org), or visit Arroyo's website at <http://www.rand.org/ard.html>.

# Contents

---

<b>Preface</b> .....	iii
<b>Figures</b> .....	ix
<b>Summary</b> .....	xi
<b>Acknowledgments</b> .....	xxiii
<b>Abbreviations</b> .....	xxv
<b>Key Individuals</b> .....	xxix
<b>CHAPTER ONE</b>	
<b>Introduction</b> .....	1
Background to the Study .....	1
Methodology .....	4
Monograph Organization .....	5
<b>CHAPTER TWO</b>	
<b>Setting Conditions for the 2008 Battle</b> .....	7
The Surge and the Baghdad Security Plan .....	7
Regaining Control of Baghdad and Isolating Sadr City .....	8
Summary and Conclusion .....	15
<b>CHAPTER THREE</b>	
<b>Conditions on the Eve of the Battle of Sadr City</b> .....	17
Political and Strategic Context .....	17
Physical and Human Terrain .....	19
The Combatants .....	23
Jaish al-Mahdi .....	23
Iraqi Security Forces .....	27
U.S. Forces .....	29
Pre-Deployment Training: Getting Ready for a Fight .....	30
The COIN Academy: Emphasizing Restraint .....	35
A Change in Context .....	37
Summary and Conclusions .....	38



CHAPTER FOUR

**The Battle Begins** ..... 39

JAM’s Initial Onslaught..... 39

Stopping JAM ..... 41

Seizing the Initiative: Operation Striker Denial..... 47

    Neutralizing Enemy Rocket Attacks with Aerial ISR and Strike Assets ..... 48

    The First Attempt to Control Launch Sites Through Active Patrolling ..... 58

    Augmented U.S. Forces Seize Launch Sites South of Route Gold ..... 61

    The Iraqi Army Attacks to Secure Route Gold..... 64

Summary and Conclusions ..... 68

CHAPTER FIVE

**Defeating JAM: Operation Gold Wall**..... 71

The Decision to Build a Wall ..... 71

Going After JAM Leaders: The MND-B “Deep Fight” ..... 78

Summary and Conclusions ..... 82

CHAPTER SIX

**Exploiting the Success of Battle**..... 83

The Two Components of Exploitation..... 84

    Maintaining the Pressure ..... 85

    Exploiting Success Through Reconstruction ..... 89

Summary and Conclusions ..... 96

CHAPTER SEVEN

**Assessing the Outcome of the Battle** ..... 97

Sadr City in the Aftermath of the 2008 Battle..... 97

Why Coalition Forces Prevailed..... 99

Summary and Conclusions ..... 103

CHAPTER EIGHT

**Reimagining Urban Combat** ..... 105

Key Insights from the Fight..... 106

    Protecting the Population Requires a Balance Between Offensive, Defensive,  
    and Stability Operations ..... 106

    Persistent ISR, Technical Intelligence, and Precision-Strike Capabilities  
    Enable the Attacker to Seize the Initiative..... 106

    Technical Capabilities Must Enable Decentralized Decision Making and  
    Small Unit Initiative..... 107

    Isolating the Enemy Enables the Counterinsurgent to Seize the Initiative ..... 108

    Ground Maneuver Remains Indispensable for Shaping the Battle and  
    Achieving Decision ..... 108

Heavy Armored Forces Have Enduring Utility in Counterinsurgency and  
 Urban Operations..... 108  
 Integrating SOF into Conventional Operations Achieves Synergy ..... 109  
 Snipers Remain an Important Enabler in Urban Operations ..... 109  
 Enduring Success Depends on Capable Indigenous Security Forces ..... 109  
 Urban Counterinsurgency Requires Forces to Transition Rapidly Between  
 Offensive, Defensive, and Stability Operations ..... 110  
 Reimagining Urban Operations as Wide-Area Security Missions ..... 110  
 Final Thoughts ..... 112

**APPENDIX**

**Analysis of Contemporary Arabic Language Sources on the Battle of Sadr City ..... 115**

**Bibliography..... 117**

**Index ..... 123**



## Figures

---

S.1.	The Baghdad International Zone and Sadr City	xv
2.1.	HMMWV Destroyed by EFP	9
2.2.	Bradley Fighting Vehicle Destroyed by a Deeply Buried IED	10
2.3.	2-82 BCT's Lines of Operation	11
2.4.	Fighting with Concrete: 2-82 BCT T-Walls	12
2.5.	2-82 BCT Soldiers Patrolling in Baghdad	13
3.1.	Attacks in Baghdad	18
3.2.	Baghdad and Sadr City	20
3.3.	Sadr City Buildings	21
3.4.	Sadr City Alleyway	22
3.5.	Operational Environment Gold in Relation to Sadr City	23
3.6.	Typical Sadr City Sector	24
3.7.	Iraqi Army Checkpoint	28
3.8.	Disposition of MND-B Maneuver Brigades	30
3.9.	3-4 BCT's Area of Operations	31
3.10.	The Multinational Chain of Command and Iraqi Security Forces in the 2008 Battle of Sadr City	32
3.11.	3-4 BCT Task Organization as of June 2008	32
3.12.	3-4 BCT Dispositions as of March 15, 2008	33
4.1.	Map of Baghdad and Sadr City	40
4.2.	1-2 SCR Soldiers and a Stryker Vehicle	42
4.3.	Sadr City Patrol	43
4.4.	RG-31 with Gyrocam	46
4.5.	Operation Striker Denial Scheme of Maneuver	49
4.6.	MQ-1 Predator and RQ-7B Shadow	50
4.7.	Aerostat	51
4.8.	RAID Tower	52
4.9.	PSDS2 Display Monitors	52
4.10.	ISR and Strike Assets Employed in the Battle of Sadr City	55
4.11.	Air Weapons Team Engagement of Enemy Rocket Crew	56
4.12.	U.S. Concept of Operations	58
4.13.	Abrams Tanks During the Battle of Sadr City	62

4.14.	Battle-Damaged Husky Vehicle Mounted Mine Detection (VMMD) System .....	66
5.1.	Operation Gold Wall.....	72
5.2.	M1 Tank and EFP on Route Gold .....	74
5.3.	Emplacing a T-Wall Section.....	75
5.4.	Unhooking a T-Wall Section.....	76
5.5.	M1 Tanks in the Battle of Sadr City.....	77
5.6.	Progress in Wall Construction and Enemy Contacts by Week, April 18 Through May 22, 2008.....	77
6.1.	IRAM .....	87
6.2.	IRAM Launch Truck .....	87
6.3.	COP Callahan After IRAM Attack.....	88
6.4.	After the Battle Reconstruction and Cleanup.....	92
6.5.	Iraqi Security Forces.....	95
8.1.	Fallujah After the Defeat of Insurgents by U.S. Forces .....	111

## Summary

---

### Background

In late March 2008 a key battle took place in Sadr City, a Shia area of Baghdad with an estimated 2.4 million residents. This battle solidified the authority of Iraqi Prime Minister Nouri al-Maliki and enabled him to extend government control to the whole of Baghdad. Thus, the battle helped create conditions in which U.S. forces could realize important contemporary operational objectives in Iraq. The U.S. and Iraqi security forces that fought the battle had as their objective the stopping of enemy activity, rather than clearing insurgents from Sadr City. Their methods and success provide lessons for how U.S. forces might reimagine the conduct of urban operations, particularly in large cities that will likely be a key challenge in the future.

This monograph adds to a small but growing body of literature on the Battle of Sadr City. The action did attract some journalistic attention, mostly because of the extensive use of unmanned drones and other high-technology assets. Indeed, *60 Minutes* aired a segment on the battle. Within U.S. military circles, such debate as has occurred has centered on the relative value of lethal force and reconstruction in counterinsurgency. In spite of the battle's importance, relatively little has been written about it.

RAND Arroyo Center's study was designed to provide a more complete description of the battle (based on primary-source material), to analyze its outcome, and to derive implications for the U.S. Army's future conduct of land operations. This monograph describes our findings.

### Methodology

The Arroyo team used after-action reports, briefings, and other primary sources and secondary sources to research this monograph. Our most valuable sources, however, were interviews conducted between August 2009 and April 2011 with a broad range of participants from the units involved in the following phases: the pre-battle surge in the vicinity of Sadr City; the Battle of Sadr City; and the post-battle stabilization and

reconstruction efforts. These participants ranged from lieutenants to the commanding general of the 4th Infantry Division. Our interviews were mostly with U.S. Army officers but also included a U.S. Air Force officer, a former Iraqi intelligence official, and U.S. government officials. These interviews provided critical information about not only what happened, but also *why* it happened.

Our understanding of the Sadrist militia comes from contemporary analyses by the International Crisis Group and other, similar organizations; from journalistic accounts; and from internal U.S. Army assessments. That said, this monograph largely reflects the perceptions of U.S. combatants and is naturally colored by their conscious and unconscious biases. To the extent that the research team could verify these accounts using other sources, we did so. Nonetheless, there is little in the way of objective data available on the battle and its aftermath. Within the time frame of this study, we could find little from the adversary's perspective.

Additionally, we consciously decided, in conjunction with our sponsor, to write this monograph at an unclassified level to enable its broad distribution. Unless otherwise noted, the information contained herein is derived from our interviews. Finally, note that some portions of this monograph draw heavily on an earlier paper on the topic published by the authors in 2011.<sup>1</sup>

## Setting Conditions

The 2008 Battle of Sadr City took place nearly 15 months after the beginning of the U.S. “surge” in Iraq. President George W. Bush stated the mission of U.S. forces when he announced the surge in a January 10, 2007, speech: “to help Iraqis clear and secure neighborhoods, to help them protect the local population, and to help ensure that the Iraqi forces left behind are capable of providing the security that Baghdad needs.”<sup>2</sup> The “Baghdad Security Plan” was a key element of the surge. Its purpose was announced by Major General Joseph Fil, Jr., commander of the Multi-National Division–Baghdad (MND-B), on February 16, 2007:

This new plan involves three basic parts: clear, control and retain. The first objective within each of the security districts in the Iraqi capital is to clear out extremist elements neighborhood by neighborhood in an effort to protect the population. And after an area is cleared, we’re moving to what we call the control operation. Together with our Iraqi counterparts, we’ll maintain a full-time presence on the streets, and we’ll do this by building and maintaining joint

<sup>1</sup> That work is David E. Johnson, M. Wade Markel, and Brian Shannon, *The 2008 Battle of Sadr City*, Santa Monica, Calif.: RAND Corporation, OP-335-A, 2011.

<sup>2</sup> President George W. Bush, quoted in Kimberly Kagan, “Enforcing the Law: The Baghdad Security Plan Begins,” *The Weekly Standard*, February 10, 2007–March 5, 2007, p. 2.

security stations throughout the city. This effort to reestablish the joint security stations is well under way. The number of stations in each district will be determined by the commanders on the ground who control that area. An area moves into the retain phase when the Iraqi security forces are fully responsible for the day-to-day security mission. At this point, coalition forces begin to move out of the neighborhood and into locations where they can respond to requests for assistance as needed. During these three phases, efforts will be ongoing to stimulate local economies by creating employment opportunities, initiating reconstruction projects and improving the infrastructure. These efforts will be spearheaded by neighborhood advisory councils, district advisory councils and the government of Iraq.<sup>3</sup>

By March 2008, implementation of the Baghdad Security Plan had achieved several results that set conditions for the battle in Sadr City. First, al-Qaeda in Iraq had been badly hurt, and its ability to create mass-casualty events significantly reduced. This allowed coalition forces to turn their attention to other destabilizing elements, such as the movement led by and identified with Moqtada al-Sadr. Second, the plan had significantly strengthened the position of the government led by Prime Minister al-Maliki, enabling it to survive a rupture with the Sadrists. Indeed, al-Maliki was moving to confront the Sadrist militias in Basra, and preparations were well under way by March 2008. Third, coalition forces had largely contained the Jaish al-Mahdi (JAM), the Sadrists' armed militia, to Sadr City, a circumstance that would severely constrain JAM's capabilities in the coming battle.

Moving U.S. troops from their forward operating bases into smaller outposts throughout Baghdad was fundamental to the execution of the Baghdad Security Plan. Key components of the unfolding operations included:

- Directly confront insurgent elements in Baghdad, thereby leading to better local security, cooperation, and human intelligence.
- Use concrete barriers and checkpoints to
  - Limit the ability of insurgents to create mass-casualty events with improvised explosive devices (IEDs), particularly large, vehicle-borne IEDs.
  - Disrupt the enemy's ability to move freely and resupply its forces.
- Integrate special operations forces (SOF), conventional forces, and all means of intelligence to locate and kill or capture insurgent leaders.
- Improve the capability and capacity of Iraqi security forces, including the Iraqi Army and police.<sup>4</sup>

---

<sup>3</sup> Major General Joseph Fil, Jr., quoted in Kagan, "Enforcing the Law," p. 3.

<sup>4</sup> Brigadier General Billy Don Farris II, interview with David E. Johnson, M. Wade Markel, and Brian Shannon, the Pentagon, March 18, 2010, and Billy Don Farris II, "Warfighter Observations During the Surge: 2nd Brigade Combat Team, 82nd Airborne Division, 'Task Force Falcon,'" briefing, c. 2008.



There was, however, one notable exception to the trend of decreasing levels of violence in Baghdad: Sadr City. The U.S. Army 4th Infantry Division, which by then was serving as MND-B and commanded by Major General Jeffery Hammond, had begun to isolate Sadr City to some degree. Within Sadr City's boundaries, however, the militantly anti-American JAM firmly controlled the population. Although SOF and conventional force raids against JAM leadership had resulted in the capture, death, or flight out of Iraq of much of the senior JAM leadership, the raids had also caused significant tension between the government of Iraq and JAM. Importantly, U.S. activity in Sadr City had largely ceased in October 2007 in the aftermath of an air strike that killed a number of Iraqi civilians. Prime Minister al-Maliki placed Sadr City off limits to U.S. ground operations. JAM's firm control of the population had already severely limited U.S. awareness of what was going on inside Sadr City. After October 2007, U.S. forces were largely blind when it came to the JAM stronghold.

It seems likely that the al-Maliki government's offensive against militias in Basra, especially JAM, precipitated JAM's own offensive in Baghdad. The al-Maliki government had been making obvious preparations for the Basra offensive since January 2008. Few U.S. officers seemed to believe that Prime Minister al-Maliki was serious about the attack, much less that it would begin as soon as March 25.

On March 23, 2008, a barrage of rockets fired from Sadr City began hitting targets in Baghdad, including the International Zone (aka the Green Zone), which houses Iraqi government offices and foreign embassies. The March 23 rocket fire appears to have been JAM's initial response to the movement of Iraqi forces into Basra. Between March 23 and March 25, JAM began to overrun Iraqi checkpoints in and around Sadr City. Other checkpoints were simply occupied by JAM fighters in collusion with their nominal adversaries in the Iraqi police.

The scale of JAM's Sadr City offensive emerged slowly. JAM had fired rockets before. Indeed, it had launched several just a few days earlier, on March 21–22, 2008, according to a company commander in 1st Squadron, 2nd Stryker Cavalry Regiment (1-2 SCR). Taking checkpoints and otherwise intimidating government forces was something JAM forces did more or less continuously. The March offensive's extent became apparent only over several days.

By March 25, however, it had become unmistakably clear that a major battle was now under way. That day, the government of Iraq launched its offensive in Basra. Al-Sadr therefore publicly ended a self-imposed cease-fire that had been in place since August 2007, and JAM forces throughout Baghdad attacked coalition and government targets with rocket and mortar fire. By the day's end, JAM had overrun about half of the Iraqi security force's checkpoints in and around Sadr City. It also stepped up rocket and mortar attacks against the International Zone. In response, Prime Minister al-Maliki directed coalition forces to stop the rocket attacks and defeat the criminal militias in Sadr City. The Battle of Sadr City was on.

## The Area of Operations

The Battle of Sadr City was centered on the Baghdad district of Thawra, which contains the neighborhoods of Sadr City, Ishbilyah, and Habbibiyah, shown in Figure S.1. The overall Sadr City area spans approximately 35 km<sup>2</sup>, roughly half the size of Manhattan (59 km<sup>2</sup>). At the time of the battle, Sadr City had, by U.S. military estimates, approximately 2.4 million residents. Figure S.1 also shows the location of the International Zone. From the Ishbilyah and Habbibiyah neighborhoods below Route Gold (Al-Quds Street),<sup>5</sup> JAM forces were firing 107mm rockets and mortars into the International Zone. The Ishbilyah neighborhood also contained the Jamiliyah Market, Baghdad's largest market east of the Tigris River. Protection money from merchants in this market supplied JAM with much of its resources. Coalition forces also had to combat and contain the Sadrist uprising in the adjacent areas east and north of Sadr City.

**Figure S.1**  
The Baghdad International Zone and Sadr City

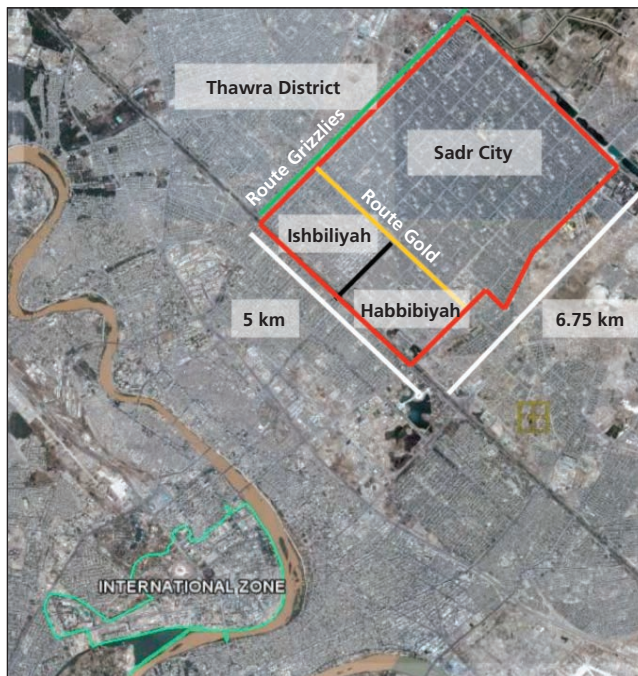

SOURCE: Provided to the authors by 1-2 SCR.

RAND RR160-S.1

<sup>5</sup> Throughout the text we refer to the same terrain feature, Al-Quds Street, both by its Iraqi name and by the name it took on U.S. graphic control measures: Route Gold.

Importantly, the International Zone was at the maximum range of the 107mm rockets and mortars that JAM was firing from its positions below Route Gold. Taking these firing points and pushing JAM above Route Gold would therefore significantly limit JAM's ability to conduct effective indirect-fire attacks against the International Zone.

### **Mission: Stop the Rockets and Defeat Criminal Militias in Sadr City**

As noted earlier, on March 25, Prime Minister al-Maliki directed the Iraqi Army and coalition forces to stop the rocket attacks and defeat the criminal militias in Sadr City. The task fell to Colonel John Hort, commander of the 3rd Brigade Combat Team, 4th Infantry Division (3-4 BCT), within whose area of operations Sadr City fell.

General Hammond focused on going after JAM leaders and keeping a lid on the rest of Baghdad. Within Sadr City, operations unfolded in four phases as MND-B responded to developments. During the first phase, U.S. forces seized control of rocket points of origin south of Route Gold while Iraqi forces attempted to secure the Ishbiliyah and Habbibiyah neighborhoods. Next, when it became clear that maneuver forces alone could not control JAM's infiltration without a barrier, U.S. forces isolated Ishbiliyah and Habbibiyah from the rest of Sadr City by building a 12-foot-tall wall along Route Gold. JAM more or less exhausted itself contesting the wall's construction. During these first two phases, 3-4 BCT and MND-B employed aerial intelligence, surveillance, and reconnaissance (ISR) and strike assets to neutralize JAM's remaining rocket capability. In the third phase, MND-B exploited the success of its security operations by orchestrating an intensive reconstruction effort. In the final phase, Iraqi security forces, hardened by their earlier fight, occupied the remainder of Sadr City.

### **The Ground Fight in Sadr City: Armor Matters**

The fight in Sadr City involved two phases: Operation Striker Denial (March 26–April 14) and Operation Gold Wall (April 15–May 15). In the first phase, 1-2 SCR attacked and seized JAM rocket-firing positions in Ishbiliyah and Habbibiyah while Task Force, 1st Combined Arms Battalion, 68th Armored Regiment (TF 1-68 CAB) quelled the Sadrist uprising in areas west and north of Sadr City proper.

When Operation Striker Denial began, U.S. forces immediately encountered JAM forces in prepared positions who were ready and willing to fight. According to U.S. commanders, however, these JAM forces were not able to fight particularly well. Nevertheless, resistance proved tougher than expected. Within a week, the 1-2 SCR lost six of its Stryker vehicles to IEDs and rocket-propelled grenades (RPGs). Colonel Hort decided to reinforce the fight with armor (M1 Abrams tanks and M2 Bradley

Fighting Vehicles) and General Hammond surged five additional companies to the 3-4 BCT.

Armor proved important in the fight, providing firepower and an ability to withstand hits from IEDs and RPGs. Iraqi security forces joined the fight on April 5 and by April 6 had fought their way to positions near Route Gold. In that fight, conducted more or less independently from U.S. forces, the Iraqi security forces held their positions against incessant JAM attacks. They gained confidence that proved critical in subsequent phases of the battle.

Unfortunately, occupying key terrain below Route Gold did not confer control of those areas to U.S. and Iraqi forces. Unimpeded movement north of Route Gold allowed JAM to assemble and to attack U.S. and Iraqi forces at will. The warren of alleyways and small buildings provided routes for JAM fighters to infiltrate the area below Route Gold. Thus, to hold what they had taken, U.S. and Iraqi forces had to deny JAM its ability to attack at will south of Route Gold. Access to the area below Route Gold was vital to JAM, so it became key terrain for Colonel Hort. Operation Gold Wall, the effort to construct a wall along the length of Route Gold, was intended to deny JAM the ability to operate in the Jamiliyah Market area.

In the 30 days of Operation Gold Wall, Colonel Hort's soldiers emplaced some 3,000 12-foot-tall and 5-foot-wide reinforced concrete T-wall sections to create a 4.6-kilometer barrier. JAM fought hard to prevent the establishment of the wall. According to Colonel Hort, the wall in effect "became a magnet for every bad guy in Sadr City." As JAM fighters attacked to stop completion of the wall, the surrounding area became a killing ground. JAM had few good options. If the wall were completed, it would curtail JAM's access to the population and the market. JAM leaders depended on that access.

Operations Striker Denial and Gold Wall were tough fights, involving three U.S. battalions and Iraqi security forces in continuous operations for six weeks. During this period, Abrams tanks and Bradley Fighting Vehicles were heavily engaged, firing 818 120mm tank main-gun rounds and 12,091 25mm rounds against JAM fighters and to detonate IEDs. Additionally, U.S. forces had to constantly adapt to JAM tactics. For example, JAM snipers used .50 caliber sniper rifles to attempt to knock out the crane that lifted the T-wall sections into place. U.S. forces responded by employing organic U.S. Army and SOF snipers in a countersniper campaign.

As the battle wore on, JAM fighters showed up in ever-decreasing numbers as U.S. and Iraqi forces steadily wore them down. Complementing the conventional fight were efforts by other U.S. government agencies and SOF to hunt and keep the pressure on JAM leaders in Sadr City. Ultimately, six U.S. soldiers died in these operations. JAM lost an estimated 700 fighters, and much of its leadership fled Sadr City for Iran or Syria. On May 11, 2008, al-Sadr asked for another cease-fire.

## The Counter-Rocket Fight

As ground maneuver elements fought to isolate Sadr City with the Gold Wall, Colonel Hort and General Hammond were working to stop JAM's indirect-fire attacks on the International Zone. By this point in Operation Iraqi Freedom, Multi-National Corps–Iraq (MNC-I) and MND-B were employing a broad range of U.S. ISR and strike resources in Baghdad.

Colonel Hort had resources directly allocated to him that were unprecedented for a brigade commander, including two U.S. Air Force MQ-1 Predator unmanned aircraft systems (UASs) armed with AGM-114 Hellfire missiles, two U.S. Army RQ-7B Shadow UASs, three aerial weapons teams (AWTs) (for a total of six AH-64 Apache attack helicopters), fixed-wing close air support, and the Guided Multiple Launch Rocket System—all available 24 hours a day. What was different compared with past practice was the manner in which these resources were employed: Colonel Hort controlled the assets without having to go through intervening headquarters. Although most of these systems were used to engage JAM fighters or rockets, on occasion, large weapons (e.g., 500-pound guided bombs) were used to destroy buildings that were sheltering snipers. Although there were other fights going on in Iraq and Baghdad, Colonel Hort's fight in Sadr City was the main effort, and he had priority.

The brigade executed a plan, developed in collaboration with MND-B, in which the BCT was to focus on JAM fighter and rocket teams while the division continued key leader attacks that were of strategic importance to the government of Iraq, MND-B, and MNC-I. As was the case in other parts of the battle, the counter-rocket fight was a learning process.

In his tactical operations center (TOC), Colonel Hort received continuous feeds from U.S. Air Force Predators (both armed and unarmed) and U.S. Army Shadow UASs. He also received information from RAID sensors, counterfire radars, and other ISR assets.<sup>6</sup> His battle staff was able to integrate this information and communicate it to operational units down to the company level via a number of relatively new technologies. For example, they used persistent surveillance and dissemination system of systems (PSDS2) to integrate the various sensors. Additionally, Colonel Hort was able to communicate in a secure chat room–like environment via secure mIRC and to pass classified information via the SECRET Internet Protocol Router down to the company level.

All of these integrated sensors, communications systems, and strike assets gave 3-4 BCT the ability to find and kill JAM rocket teams and destroy other targets (e.g., mortars). Engagements happened in several ways. First, a radar or other sensor detected

---

<sup>6</sup> See *Defense Industry Daily*, "The USA's RAID Program: Small Systems, Big Surveillance Time," August 24, 2011. The article notes: "The RAID [rapid aerostat initial deployment] program is a combination of cameras and surveillance equipment positioned on high towers and aerostats, in order to monitor a wide area around important locations and bases."

a rocket launch. A Shadow UAS was then vectored to the location of the launch and proceeded to follow the target. Finally, a Predator or Apache killed the target. Predators were particularly useful because JAM was expected to have SA-7 MANPADS (man-portable air-defense systems) and the UASs enabled attacks on JAM without putting Apache crews at risk. Second, skilled intelligence personnel in 3-4 BCT headquarters were tasked with watching the ISR feeds on large screens in the TOC. These individuals were “dedicated scouts” who watched the area under surveillance for enemy activity; when such activity was identified, the process of bringing assets to bear was begun. Third, ground maneuver forces who detected JAM activity initiated the acquisition and attack processes. What is important is that the brigade commander and his battle staff had these resources pushed down to them—without intervening levels of command and authority—and could execute mission command. Higher echelons resourced the fight and managed the deeper operations beyond the brigade.

Like the countersniper fight, the counter-rocket fight evolved over time. At first, rocket launch teams were attacked immediately after they had fired. However, the brigade battle staff soon developed “tactical patience,” realizing that it was likely hitting only low-level operatives with vehicles and launch rails. Eventually, the staff adopted a best practice of using an ISR platform to “watch the rail” and follow it. When the operatives returned to a supply point or a command location to get additional rockets and instructions, the staff saw the opportunity to strike, hitting not only the operatives but higher elements of the network as well.

## Exploitation

MND-B exploited its success in neutralizing JAM with stability operations to secure Ishbilyyah and Habbibiyah. These efforts were intensified after al-Sadr declared a cease-fire on May 12. Focused reconstruction efforts and information operations in those neighborhoods were intended to influence popular perceptions north of Route Gold as well. Even before fighting subsided completely, U.S. forces resumed applying relentless pressure against JAM’s organization. As the reality of JAM’s defeat became clearer, the area’s inhabitants began providing a flood of reliable intelligence that greatly facilitated this effort.

As the battle subsided, two key realities became apparent to Iraqis living south of (“below”) the wall along Route Gold. First, Iraqi Army and national police forces were in place and providing security. For residents, this harkened back to pre-Operation Iraqi Freedom days: Iraqis were now in charge, and not the coalition forces who would eventually leave Iraq. Second, as security was restored to the area below Route Gold, General Hammond, his subordinate commanders, and the reserve engineer brigade commander working for General Hammond, Brigadier General Jeffrey Talley, began an intense effort to improve conditions below the wall. Much of this was done by

enabling Iraqi small businesses, which gave Sadr City's population a stake in the new order. Thus, the population was able to see more permanent progress, and as conditions improved, the local citizenry became invested in maintaining their security and began providing intelligence to Iraqi and U.S. forces.

When, on May 12, Sadr declared a unilateral cease-fire, it is likely that he was simply putting the best face possible on the existing situation. His forces had suffered huge losses, and key leaders had either fled or been killed. The population was growing restive, not only because JAM was perceived as provoking confrontations that resulted in civilian casualties but also because of JAM's depredations. On May 20, unopposed elements of the Iraqi Army's 44th Brigade occupied the remainder of Sadr City.

## **Key Insights from the Fight**

The defeat of JAM in Sadr City during the six weeks of high-intensity operations yields several insights that bear highlighting:

- Protecting the population requires a balance between offensive, defensive, and stability operations.
- Persistent ISR, technical intelligence, and precision-strike capabilities enable the attacker to seize the initiative.
- Technical capabilities must enable decentralized decision-making and small unit initiative.
- Isolating the enemy enables the counterinsurgent to seize the initiative.
- Ground maneuver remains indispensable for shaping the battle and achieving decision.
- Heavy armored forces have enduring utility in counterinsurgency and urban operations.
- Integrating SOF into conventional operations achieves synergy.
- Snipers remain an important enabler in urban operations.
- Enduring success depends on capable indigenous security forces.
- Urban counterinsurgency requires forces to transition rapidly between offensive, defensive, and stability operations.

## **Reimagining Urban Operations as Wide-Area Security Missions**

Two general models for dealing with insurgent control of urban areas have become apparent in recent years. The first is the approach taken by the Russian Federation in the Chechen city of Grozny in December 1999–February 2000 and by U.S. forces in the Iraqi city of Fallujah in November 2004. Insurgents in these cities were viewed as

cancers that had to be excised. In both of these cases, the cities were essentially besieged and then stormed, a course of action made possible by their geographic isolation. Non-combatants were told to leave before military operations within the cities commenced. Anyone who remained was, in general, viewed as a combatant in what became a block-by-block clearing operation supported by massive amounts of firepower.

Not surprisingly, both cities suffered significant damage. Additionally, casualties among Russian and U.S. forces were high. Although reliable figures are difficult to ascertain, the Russian Federation suffered at least 600 dead (mostly in Grozny, it is assumed) and likely many more wounded in Chechnya between December and early January. In Fallujah, U.S. forces suffered 70 dead and more than 600 wounded. Thus, this model of urban warfare anticipates and accepts extensive collateral damage and relatively high numbers of friendly casualties.

The 2008 Battle of Sadr City offers a second model for wresting control of a city from insurgents: treating an urban area as a wide-area security mission. In Sadr City, unlike in Grozny and Fallujah, telling the civilians to leave what was about to become a high-intensity battlefield simply was not feasible. Sadr City had 2.4 million residents, and there was nowhere for them to go: Sadr City is part of the larger city of Baghdad and, unlike Grozny and Fallujah, is not geographically isolated. These conditions in Sadr City may be representative of the future challenges of urban operations, and they will likely worsen as urban areas around the globe become more densely populated. The objective was not to take and clear Sadr City but to create conditions that would make it both impossible for the insurgents to operate effectively and possible to restore security to the broader population.

Thus, in the Battle of Sadr City, the focus was on enemy fighters and their capabilities. U.S. forces deprived the enemy of the ability to affect events at the operational and strategic levels of war. JAM's control of Sadr City was a perennial problem, but what made its March 2008 offensive problematic was JAM's ability to strike the Green Zone with indirect fires (mainly via rockets). Attacks on the Green Zone threatened to derail the Basra offensive and thereby reveal that the al-Maliki government was fatally ineffective. However, 3-4 BCT took JAM's offensive capability away by employing determined ground maneuver, which combined infantry and armored vehicles, with support from pervasive ISR and precision-strike capabilities, which were provided by UASs, attack helicopters, artillery, and CAS. Without its indirect-fire capability, JAM could only react locally as coalition forces exploited human and technical intelligence to hunt down its remaining leaders under extremely one-sided conditions.

Finally, Sadr City demonstrates that one of the keys to fighting an urban adversary is to create a situation that will force the enemy to surrender the advantages of the city. This is the art of reimagining urban warfare, and it clearly has doctrinal, organizational, materiel, and training implications for both the U.S. Army and the joint force. In the case of the Battle of Sadr City, building the wall along Route Gold threatened to deny JAM access to key terrain and, as Colonel Hort related during an interview



with the authors, “agitated the enemy.” Quite simply, JAM had to contest the wall or face isolation. In the words of one U.S. officer, the wall was the equivalent of a Roman siege engine about to breach a city’s defenses. It created a situation that was intolerable to JAM, and JAM had to come out and fight. In so doing, the enemy attacked U.S. forces that now had the initiative and were in a position of enormous advantage. JAM lost, and the coalition victory in the Battle of Sadr City offers important lessons for the prosecution of future urban operations.

## Acknowledgments

---

This study began as the result of a conversation between several RAND Arroyo Center participants and General John M. (Jack) Keane (U.S. Army, retired), former U.S. Army Vice Chief of Staff; Lieutenant General Robert P. Lennox, U.S. Army Deputy Chief of Staff, G-8; Lieutenant General William J. Lennox, Jr. (U.S. Army, retired), former Superintendent of the U.S. Military Academy at West Point; and Timothy Muchmore, Director of the U.S. Army Quadrennial Defense Review Office, G-8. We were discussing a then-recent Israeli operation in Gaza (Operation Cast Lead), which ended in January 2009. During the conversation, several participants noted that there were similarities between Cast Lead and a battle coalition forces had fought in Iraq in 2008: the Battle of Sadr City. The Arroyo participants in the conversation had heard little of this operation. As we found during our subsequent research and discussions with broader audiences, the battle was only briefly noted and never fully analyzed. Through this project, we have sought to make the battle and its effects more widely known and to document lessons from Sadr City that we believe have great relevance for how the U.S. Army prepares for future operations.

We would like to acknowledge the two individuals who most understood the importance of this project and supported it throughout its course: General Robert Lennox and Mr. Muchmore. Dozens of participants in the battle also gave generously of their time in the form of interviews and follow-on discussions. Their first-hand accounts of their experiences in the events we describe in this report were absolutely invaluable. They include: Lieutenant Colonel Robert S. Ballagh, Major Jonathan Bradford, Sergeant Corey Collings, Lieutenant Colonel John DiGiambattista, Major Will Downing, Colonel Brian Eifler, Brigadier General Billy Don Farris II, Major Bryan Gibby, Lieutenant Colonel Barry Graham, Major General Will Grimsley, Major General Jeffery Hammond, Colonel Bob Hatcher, Colonel (Promotable) John Hort, Lieutenant Colonel Chris Keller, Command Sergeant Major Steve Lewis, Major Todd Looney, Lieutenant Colonel Gerry Messmer, Captain Kyle Morse, Major Brian North, Major Jason Northrop, Colonel Mike Pappal, Colonel Mike Pemrick, Colonel Jim Rainey, Captain Clint Rausch, Ms. Marcie Ries, Lieutenant Colonel Steve Stover, Major General Jeffrey Talley, Major Gina Thomas, Lieutenant Colonel Kurt Thomp-

son, and Lieutenant Colonel Frank Zimmerman.<sup>7</sup> We also appreciate the efforts of our RAND colleague Christopher Rizzi for his efforts to locate Arabic-language sources on the 2008 Battle of Sadr City. Finally, the reviewers of this report—Colonel Gian Gentile and David Shlapak—provided thorough and very useful reviews.

The efforts of all these individuals contributed immeasurably to this product. We owe them all an enormous debt of gratitude.

---

<sup>7</sup> Ranks were current as of this writing.

## Abbreviations

---

AQI	al-Qaeda in Iraq
AR	armor
AWT	air weapons team
BBC	British Broadcasting Corporation
BCT	brigade combat team
BSB	brigade support battalion
CAB	combined arms battalion
CAS	close air support
CENTCOM	Central Command
CJSOTF	combined joint special operations task force
CLC	concerned local citizens
COIN	counterinsurgency
COP	combat outpost
DAC	district advisory council
DCO	deputy commanding officer
ECP	checkpoint
EFP	explosively formed penetrator
FOB	forward operating base
GMLRS	Guided Multiple Launch Rocket System
HEMMTT	Heavy Expanded Mobile Tactical Truck
HMMWV	High Mobility Multipurpose Wheeled Vehicle
HQ	headquarters
IA	Iraqi Army
IED	improvised explosive device
IFV	infantry fighting vehicle

IN	infantry
IRAM	improvised rocket assisted mortar
ISCI	Islamic Supreme Council of Iraq
ISF	Iraqi Security Forces
ISR	intelligence, surveillance, and reconnaissance
IZ	International Zone
JAM	Jaish al-Mahdi
JSS	Joint Security Station
JSTARS	Joint Surveillance Target Attack Radar System
LOS	line of sight
MANPADS	man-portable air-defense system
MICLIC	mine clearing line charge
MMPV	medium mine protected vehicle
MNC-I	Multi-National Corps–Iraq
MND-B	Multi-National Division–Baghdad
MNF-I	Multi-National Force–Iraq
MRAP	mine resistant ambush protected
NAC	neighborhood advisory council
NAI	named area of interest
OE	operational environment
PDSS	pre-deployment site survey
PL	Phase Line
PSDS2	persistent surveillance and dissemination system of systems
RAID	rapid aerostat initial deployment
RPG	rocket-propelled grenade
RWS	remote weapons system
SCR	Stryker cavalry regiment
SIGINT	signals intelligence
SM	secure market
SN	secure neighborhood
SOF	special operations forces
SR	secure route
TACP	tactical air control party
TF	task force

TOC	tactical operations center
UAS	unmanned aerial system
UNHCR	United Nations High Commissioner for Refugees
USIP	United States Institute for Peace
VBIED	vehicle borne improvised explosive device
VTC	video teleconference



## Key Individuals

---

The individuals listed below played key roles in the Battle of Sadr City. Many of them were also sources for this report. In the report, we describe the individual's role in the battle when that individual is introduced, but not thereafter. We provide this list to help readers keep track of whom we are citing and why that individual's perspective matters. It includes the name, military rank where appropriate, and a brief synopsis of the individual's significance. Individuals are listed under the organization to which they belonged. Except for Prime Minister Nouri al-Maliki, we have not listed Iraqi officials still in Iraq by their real name lest this report prove awkward to them in the new Iraq.

Name or Organization	Significance/Role in the Battle
<b><i>Iraq</i></b>	
Nouri al-Maliki	Prime Minister of Iraq.
Omar al-Shahery	Former intelligence official in the Iraqi Ministry of Defense.
General X	Commander, 42nd Brigade of the Iraqi Army.
Lieutenant Colonel Y	Commander of the 3rd Battalion, 42nd Brigade of the Iraqi Army. His battalion's successful attack to Route Gold demonstrated that the Iraqi Army could succeed under pressure, and inspired confidence for subsequent operations.
General M.	Commander of the 44th Brigade of the Iraqi Army during its occupation of Sadr City.
<b><i>United States</i></b>	
1st Cavalry Division	The 1st Cavalry Division served as Multi-National Division–Baghdad (MND-B) during the surge, immediately prior to the 4th Infantry Division's assumption of that responsibility.
Major General Joseph Fil, Jr.	Commander, 1st Cavalry Division and MND-B.
4th Infantry Division	The 4th Infantry Division served as MND-B during the Battle of Sadr City and its aftermath.
Major General Jeffery Hammond	Commander, 4th Infantry Division and MND-B.



Name or Organization	Significance/Role in the Battle
Brigadier General Will Grimsley	Assistant Division Commander for Operations (ADC-O) for 4th Infantry Division and MND-B.
Lieutenant Colonel Jim Rainey	Division Operations Officer (G-3), MND-B.
Lieutenant Colonel Barry Graham	Division Intelligence Officer (G-2), MND-B.
Lieutenant Colonel Frank Zimmerman	Division Information Operations Officer (G-7), MND-B.
Lieutenant Colonel Gerry Messmer	Division Civil Military Operations Officer (G-9), MND-B.
Lieutenant Colonel Steve Stover	Division Public Affairs Officer (PAO), MND-B.
Major Mark Rosenberg	Team Chief, Military Transition Team attached to the 3rd Battalion, 42nd Iraqi Army Brigade.
2nd Brigade Combat Team, 82nd Airborne	2-82 BCT was responsible for Sadr City until the eve of the battle. It established conditions critical to U.S. success and evolved many of the concepts of operation used in the battle.
Colonel Billy Don Farris	Commander, 2-82 BCT.
4th Brigade Combat Team, 10th Mountain Division	4-10 BCT was responsible for the area of operations immediately adjacent to Sadr City to the northeast.
Major Rob Ballagh	Brigade Operations Officer (S-3), 4-10 BCT.
3rd Brigade Combat Team, 4th Infantry Division	3-4 BCT controlled most U.S. actions during the battle.
Colonel John Hort	Commander, 3-4 BCT.
Lieutenant Colonel Mike Pemrick	Deputy Commander, 3-4 BCT. Colonel Pemrick oversaw efforts to develop Iraqi capabilities.
Major John DiGiambattista	Brigade Operations Officer (S-3), 3-4 BCT.
Major Bryan Gibby	Brigade Intelligence Officer (S-2) 3-4 BCT.
Major Will Downing	Brigade Chief of Operations (Battle Major), 3-4 BCT.
Major Gina Thomas	Brigade Communications Officer (S-6), 3-4 BCT.
Major Brian North	Team Chief, 3-4 BCT Military Transition Team (MITT), attached to the 42nd Iraqi Army Brigade.
1st Squadron, 2nd Stryker Cavalry Regiment	1-2 SCR, attached to 3-4 BCT, experienced the brunt of the initial fighting.
Lieutenant Colonel Dan Barnett	Commander, 1-2 SCR.
Major Chris Keller	Executive Officer, 1-2 SCR.
Captain Jon Bradford	Commander, Company B, 1-2 SCR (B/1-2 SCR).
First Lieutenant Kenneth Elgort	Platoon Leader, 3rd Platoon, B/1-2 SCR.
Captain Jason Northrup	Commander, Company C, 1-2 SCR (C/1-2 SCR).
First Sergeant Kyle Morse	Platoon Leader, 2nd Platoon, C/1-2 SCR.

Name or Organization	Significance/Role in the Battle
1st Battalion, 68th Armor Regiment; also referred to as 1st Combined Arms Battalion, 68th Armored Regiment (TF 1-68 CAB)	Task Force 1-68 Armor (TF 1-68 AR) was one of 3-4 BCT's organic combined arms battalions. Initially, the battalion was responsible for areas around Sadr City's perimeter. Later, it was committed to seize and hold rocket launch sites and help build the wall along Route Gold.
Lieutenant Colonel Mike Pappal	Commander, TF 1-68 AR.
Captain Todd Looney	Commander, Company C, 1-68 AR (C/1-68 AR).
1st Battalion, 6th Infantry Regiment	Task Force 1-6 Infantry (TF 1-6 IN) was a "legacy" battalion task organized with one tank and two infantry companies. It deployed to constitute part of MNF-I reserve, and was committed to the Battle of Sadr City during its latter stages.
Lieutenant Colonel Brian Eifler	Commander, TF 1-6 IN.
Major Kurt Thompson	Battalion Operations Officer (S-3), TF 1-6 IN.
Captain Erik Oksenvaag	Commander, C Company, TF 1-6 IN (C/1-6 IN).
237th Engineer Company	The 237th was a Virginia Army National Guard Engineer Company that served as 3-4 BCT's primary route clearance company during the battle.
Specialist Corey Collings	Gunner, 237th Engineer Company.
926th Engineer Brigade	The 926th was an Army Reserve unit serving as the MND-B Engineer Brigade. As such, it had responsibility to support MND-B stabilization and reconstruction efforts throughout Baghdad. General Hammond also assigned it joint responsibility with 3-4 BCT for reconstruction in Sadr City specifically.
Brigadier General Jeff Talley	Commander, 926th Engineer Brigade.



## Introduction

---

RAND Arroyo Center was asked by the Department of the Army to analyze the 2008 Battle of Sadr City. The purpose was to provide a more complete description of the battle, to assess its outcome, and to derive lessons learned that can inform a broader understanding of urban operations. The ultimate purpose of the analysis is to help the U.S. Army understand what capabilities it may need in the future to contend with the challenges posed by combat in large cities.

On March 23, 2008, Moqtada al-Sadr's Jaish al-Mahdi (JAM) militia precipitated what became known as the Battle of Sadr City with a barrage of rockets aimed at the Green Zone. That battle would cost JAM control of Sadr City, its main stronghold in Baghdad. It would also enable the government of Iraq to establish ascendancy in Baghdad and the Iraqi political landscape.

The battle itself unfolded the way doctrine says a battle should, which battles seldom do. Al-Sadr's JAM attacked on March 23, 2008, by launching a barrage of rockets at the Green Zone and assaulting Iraqi security forces positions throughout Baghdad. Coalition forces held their positions and confined the fiercest fighting to Sadr City in the 3rd Brigade Combat Team, 4th Infantry Division's (3-4 BCT) area of operations. Coalition forces then counterattacked, built a barrier that isolated Sadr City (the Gold Wall) and apparently broke JAM's capacity for organized violence in the process. At this point, the victor is supposed to exploit his advantage and consolidate the victory. Coalition forces did just that, applying unrelenting pressure to Shia insurgent networks and eroding the Sadrist movement's popular support through a massive reconstruction program.

### Background to the Study

This monograph adds to a small but growing body of literature on the Battle of Sadr City. The action did attract some journalistic attention, mostly because of the extensive use of UASs (unmanned aerial systems) and other high-technology assets. Indeed,

the CBS News program *60 Minutes* aired a segment on the battle.<sup>1</sup> Michael Gordon and Bernard Trainor describe the battle in some detail in their recent book, *The Endgame*. Gordon and Trainor focus principally on the interaction of battlefield events and the war's strategic course.<sup>2</sup> The Institute for the Study of War published an accurate descriptive summary of the battle in August 2008, based mostly on press reports.<sup>3</sup> Other sources mention it in passing, interpreting its significance but not providing much underlying detail about its conduct. Irish journalist Patrick Cockburn attributes the outcome to Moqtada al-Sadr's political calculations, while Adeed Dawisha credits Prime Minister Nouri al-Maliki's resolute behavior with fostering a nonsectarian political climate. Neither has much to say about how the battle's conduct helped produce the resulting outcome.<sup>4</sup> Within U.S. military circles, such debate as has occurred has centered on the relative value of lethal force and reconstruction in counterinsurgency.<sup>5</sup> In spite of the battle's importance, relatively little has been written about it, especially its implications for the conduct of future urban operations.

There is also little discussion of the battle from the Iraqi perspective; we will recap it here. Research of Arabic-language newspapers, blogs, and Internet forums did not turn up much about local Iraqis' or Shiite militias' attitudes about the Battle of Sadr City or the American forces' "Golden Wall." However, several online sources offered what may be useful context, at least for the conflict narrative. These sources tend to confirm the linkage of the Battle of Sadr City with the Maliki government's Basra operation and the importance of the wall isolating large portions of Sadr City as a provocation to militias affiliated with Jaish al Mahdi. Appendix A details the research team's analysis of contemporary Arabic-language sources.

At the beginning of this project our sponsors were particularly interested in how 3-4 BCT managed the high-technology resources allocated to it for the battle, which was the centerpiece of the *60 Minutes* story. As we began our research, however, it soon became apparent that there was much more to this battle than the employment of unmanned aerial systems (UASs) and high-technology sensors. Even the combat that took place from March through May 2008 is only part of the story. The critical setting of conditions for the battle had been ongoing since mid-2007, when the 1st Cavalry

---

<sup>1</sup> Lesley Stahl, "The Battle of Sadr City," *60 Minutes*, October 12, 2008.

<sup>2</sup> Michael R. Gordon and Bernard E. Trainor, *The Endgame: The Inside Story of the Struggle for Iraq, from George W. Bush to Barack Obama*, New York: Pantheon Books, 2012.

<sup>3</sup> Marisa Cochrane, *Special Groups Regenerate*, Washington, D.C.: Institute for the Study of War, 2008.

<sup>4</sup> Patrick Cockburn, *Moqtada al-Sadr and the Battle for the Future of Iraq*, New York: Scribner, 2008, pp. 98–106; Adeed Dawisha, "Iraq: A Vote Against Sectarianism," *Journal of Democracy*, Vol. 21, No. 3, July 2010, pp. 26–40. In a May 2010 article, Geraint Hughes does not even mention the battle, even though he notes the simultaneous battle in Basra (see Geraint Hughes, "The Insurgencies in Iraq, 2003–2009: Origins, Developments and Prospects," *Defence Studies*, Vol. 10, No. 1, May 2010, pp. 152–176).

<sup>5</sup> See, for example, Craig Collier, "Two Cheers for Lethal Operations," *Armed Forces Journal International*, August 2010.

Division, acting as Multi-National Division–Baghdad (MND-B), had begun isolating the Sadr City district from the rest of the city and disrupting Sadrist networks with targeted raids against key individuals. When the 4th Infantry Division assumed responsibilities as MND-B, it continued this effort. The 2nd Brigade Combat Team, 82nd Airborne Division (2-82 BCT) was the brigade within whose sector Sadr City fell.

Once battle was joined, high-technology weapons did play a critical role in neutralizing JAM's rocket-launching capability, but defeating the rocket launches also required traditional ground maneuver urban combat, because 3-4 BCT had to seize and control the launch sites south of Sadr City from which most of the rockets were fired. Ultimately, 3-4 BCT built a massive concrete wall (the Gold Wall) to deny enemy infiltration into the areas with the most potential rocket-launching sites within range of the Green Zone.

Combat also gave participating Iraqi security forces a critical shaking out. The Iraqi Army entered this battle a "checkpoint Army," infiltrated and cowed by JAM. During the battle, Iraqi soldiers advanced into contested territory and held their positions in the face of incessant enemy attacks. At the battle's end, the Iraqi Army had established an effective monopoly of violence throughout Sadr City. To those familiar with the situation in Iraq and the uneven progress attained by Iraqi security forces, that assessment might seem overly optimistic. In the months following the battle, however, Iraqi forces in Sadr City suffered few attacks and captured several key enemy leaders and weapons caches. Chapter Six provides more detailed support for this assertion. Had the Iraqi Army not attained this level of competence, the battle would have achieved very little. Control would have reverted to JAM when January 2009's provincial elections marked the end of U.S. forces' remit in Baghdad.

Having largely neutralized JAM's ability to control Sadr City, MND-B launched an intense reconstruction effort. The Army Reserve's 926th Engineer Brigade worked through local Iraqis to improve infrastructure and provide essential services. By focusing on building local capacity, the 926th also created a constituency for a new social and political order not dominated by JAM and al-Sadr's political movement. This reconstruction effort also created conditions for the government of Iraq to provide services to the district and extend its authority over Sadr City for the first time.

It is difficult to assess the relative importance of these different aspects to the battle's final outcome. Building the massive wall along Al-Quds Street, or Route Gold as it appeared on U.S. maps, was probably the single most important element of the battle, however. Faced with the prospect of being trapped in Sadr City, then picked off one by one, JAM's mid-level leaders committed their raw forces to a decisive battle on unequal terms against heavily armed and armored U.S. forces. They lost. On May 12, 2008, Moqtada al-Sadr offered a cease-fire to the Iraqi government. To be sure, al-Sadr's reasoning remains opaque to outsiders, but it seems likely that JAM had little remaining military capability with which to resist further. Building a wall had forced JAM to fight itself out.

When the actual Battle of Sadr City began in March 2008, it followed an already intensive year-long shaping effort by 2-82 BCT, which was operating under the control of the 1st Cavalry Division. 3-4 BCT's main heavy combat phase of the battle lasted two months, with an intensive reconstruction and information operations effort overlapping both the shaping and combat phases, and which intensified until U.S. forces withdrew from Baghdad proper. Thus, the reader should not place undue emphasis on any particular aspect of the battle. Each played a critical role in the final outcome of the battle and the post-battle operations. Major General Jeffery Hammond, MND-B's commander, pushed each of his subordinate elements to their absolute limit. Maneuver elements routinely patrolled for 16 of 24 hours daily. Information operations went on nonstop, at a rate that simply overwhelmed JAM's organization. Several hardened officers, with repeated deployment experiences, told us that they had never worked harder. Some of these efforts may have had greater impact than others, and the sheer volume of activity often overwhelmed attempts to synchronize different lines of operation. In short, MND-B relentlessly applied every tool at its disposal. In many respects, MND-B overwhelmed the enemy with a multidimensional onslaught, carried out on every available logical and geographical line of operation.

## Methodology

The Arroyo team used after-action reports, briefings, and other primary sources and secondary sources to research this report. Our most valuable sources, however, were interviews conducted between August 2009 and April 2011 with a broad range of participants from the units involved in the following phases: the pre-battle surge in the vicinity of Sadr City; the Battle of Sadr City; and the post-battle stabilization and reconstruction efforts. These participants ranged from lieutenants to the commanding general of the 4th Infantry Division. Our interviews were mostly with U.S. Army officers but also included a U.S. Air Force officer, a former Iraqi intelligence official, and U.S. government officials. These interviews provided critical information about not only what happened but *why* it happened.

Our understanding of the Sadrist militia comes from contemporary analyses by the International Crisis Group and other, similar organizations; from journalistic accounts; and from U.S. Army assessments. That said, this report largely reflects U.S. combatant perspectives about the battle.

Additionally, we consciously decided, in conjunction with our sponsor, to write this report at an unclassified level to enable its broad distribution. Unless otherwise noted, the information contained herein is derived from our interviews; in general,

interviewees are not identified by name. Finally, note that some portions of this monograph draw heavily on an earlier paper on the topic published by the authors in 2011.<sup>6</sup>

## Monograph Organization

Chapter Two documents the operations that began with the surge, which set the conditions for the Battle of Sadr City. Chapter Three describes the conditions in Baghdad just prior to the battle. Chapter Four examines the initial operations that occurred in March 2008 in response to the launching of rocket and mortar attacks on the International (“Green”) Zone from Sadr City. Chapter Five focuses on the second phase of the operation that sought to stop enemy infiltration from Sadr City into market areas important to the insurgents. Chapter Six examines efforts by coalition forces to exploit the changed conditions in Sadr City after the battle. In Chapter Seven we present our analysis of the factors that decided this particular battle, at this particular place and time. Finally, Chapter Eight assesses the implications of the Battle of Sadr City for future urban operations.

---

<sup>6</sup> That work is David E. Johnson, M. Wade Markel, and Brian Shannon, *The 2008 Battle of Sadr City*, Santa Monica, Calif.: RAND Corporation, OP-335-A, 2011.





## Setting Conditions for the 2008 Battle

---

MND-B and 3-4 BCT drew heavily on concepts of operation developed during the “surge” during the 2008 Battle of Sadr City. This chapter describes how those concepts emerged and evolved. U.S. forces had evolved a new concept of operation for controlling an urban insurgency. Isolating particular areas of operation with concrete T-walls was central to that concept. Doing so denied insurgents the ability to strike at will, thereby giving coalition forces the initiative. Coalition forces would then methodically dismantle insurgent networks fixed within these walls with intelligence-driven raids. By the end of 2007, U.S. forces were employing these concepts against Jaish al-Mahdi in Sadr City.

### The Surge and the Baghdad Security Plan

The 2008 Battle of Sadr City took place nearly 15 months after the beginning of the U.S. “surge” in Iraq. President George W. Bush stated the mission of U.S. forces when he announced the surge in a January 10, 2007 speech: “to help Iraqis clear and secure neighborhoods, to help them protect the local population, and to help ensure that the Iraqi forces left behind are capable of providing the security that Baghdad needs.”<sup>1</sup> The “Baghdad Security Plan” was a key element of the surge. Its purpose was announced by Major General Joseph Fil, Jr., commander of the 1st Cavalry Division, which was serving as MND-B, on February 16, 2007:

This new plan involves three basic parts: clear, control and retain. The first objective within each of the security districts in the Iraqi capital is to clear out extremist elements neighborhood by neighborhood in an effort to protect the population. And after an area is cleared, we’re moving to what we call the control operation. Together with our Iraqi counterparts, we’ll maintain a full-time presence on the streets, and we’ll do this by building and maintaining joint security stations

---

<sup>1</sup> President George W. Bush, quoted in Kimberly Kagan, “Enforcing the Law: The Baghdad Security Plan Begins,” *The Weekly Standard*, February 10, 2007–March 5, 2007, p. 2.

throughout the city. This effort to reestablish the joint security stations is well under way. The number of stations in each district will be determined by the commanders on the ground who control that area. An area moves into the retain phase when the Iraqi security forces are fully responsible for the day-to-day security mission. At this point, coalition forces begin to move out of the neighborhood and into locations where they can respond to requests for assistance as needed. During these three phases, efforts will be ongoing to stimulate local economies by creating employment opportunities, initiating reconstruction projects and improving the infrastructure. These efforts will be spearheaded by neighborhood advisory councils, district advisory councils and the government of Iraq.<sup>2</sup>

Moving U.S. troops from their forward operating bases into smaller outposts throughout Baghdad was fundamental to the execution of the Baghdad Security Plan. Key components of the unfolding operations included

- Moving U.S. ground forces into Baghdad, where they could directly confront insurgent elements, thereby leading to better local security, cooperation, and human intelligence.
- Using concrete barriers and checkpoints to
  - Limit the ability of insurgents to create mass-casualty events with improvised explosive devices (IEDs), particularly large, vehicle-borne IEDs.
  - Disrupt the enemy's ability to move freely and resupply its forces.
- Integrating special operations forces (SOF), conventional forces, and all means of intelligence to locate and kill or capture insurgent leaders.
- Improving the capability and capacity of Iraqi security forces, including the Iraqi Army and police.<sup>3</sup>

## Regaining Control of Baghdad and Isolating Sadr City

Sadr City fell within the area assigned under the surge to the 2nd Brigade Combat Team, 82nd Airborne Division, commanded by Colonel Billy Don Farris, II. 2-82 BCT, which was the first of the surge brigades to arrive in Iraq, was initially deployed to Camp Taji (a forward operating base [FOB] some 45 kilometers north of Baghdad), but soon redeployed to northeast Baghdad, which contained nearly 40 percent of the city's population. It was fully operational on January 28, 2007.

The conditions in Baghdad at the time, described by Colonel Farris in a briefing after his brigade left Iraq, were horrendous. 2-82 BCT was in an

---

<sup>2</sup> Major General Joseph Fil, Jr., quoted in Kagan, "Enforcing the Law," p. 3.

<sup>3</sup> Farris interview and Farris, "Warfighter Observations During the Surge."

extremely volatile area of Baghdad with significant Sunni and Shia populations and fault lines; sectarian murders averaged 200–250 per month; wholesale displacement of thousands of families; Iraqi Police corruption rampant and lethal AQI VBIED [al-Qaeda in Iraq vehicle-borne improvised explosive device] networks sustained the cycle of violence . . . enormous strategic implications.

Deserted neighborhood streets; busted water pipes and backed-up sewage; significant rubble and garbage; stores damaged and closed; large number of displaced personnel.

Every day we discovered bodies dumped in various neighborhoods.

On the East side, JAM took over the police force and systematically began killing Sunnis to establish control of mixed neighborhoods.

Sunni protectionists align themselves with AQI to survive.

American Forces operating from large Forward Operating Bases and “commuting” to work; getting killed by the explosively formed penetrator (EFP).<sup>4</sup>

Figures 2.1 and 2.2 show the aftermath of an IED and EFP respectively.

**Figure 2.1**  
**HMMWV Destroyed by EFP**



SOURCE: Farris, “Warfighter Observations During the Surge.”

RAND RR160-2.1

<sup>4</sup> Farris interview and Farris, “Warfighter Observations During the Surge.”

**Figure 2.2**  
**Bradley Fighting Vehicle Destroyed by a Deeply Buried IED**



SOURCE: Farris, "Warfighter Observations During the Surge."

RAND RR160-2.2

2-82 BCT's operations were centered on four lines of operation: security, transition, governance, and economic development. The desired end state and effects of its operations are shown in Figure 2.3.

During its fifteen months in Baghdad, 2-82 BCT defeated AQI in its sector through a combination of restricting access to contested areas and targeted raids to kill or capture key nodes in AQI's networks. In Farris's analysis, the biggest threat to the population and, hence, Baghdad's civil peace, was the car bomb. With their mobility and their ability to carry large quantities of explosives, car bombs, or VBIEDs as they became known, could rapidly enter congested areas and kill large numbers of people. If the car bomb could not reach its target, however, the damage would be limited. The process generally began with literally walling off a troubled neighborhood with twelve-foot-tall concrete T-walls. When Farris walled off Adhamiyah, VBIED attacks dropped dramatically, especially in terms of their impact. At worst, a few guards at a checkpoint might be killed instead of scores of shoppers at a market.<sup>5</sup> Figure 2.4 shows the extent of the walling effort that 2-82 BCT accomplished during its tour of duty.<sup>6</sup>

<sup>5</sup> Farris interview. Brigadier General Farris was wounded during the construction of the wall around Adhamiyah. See "A U.S. Combat Brigade Commander Was Shot by a Sniper While Surveying the Construction of a Wall to Protect a Sunni Arab Enclave in Baghdad, the U.S. Military Said on Monday," *Reuters*, May 7, 2007.

<sup>6</sup> T-wall sections are made of reinforced concrete. Each section weighs between 12,000 and 14,000 pounds and is twelve feet tall and five feet wide.

**Figure 2.3**  
**2-82 BCT's Lines of Operation**

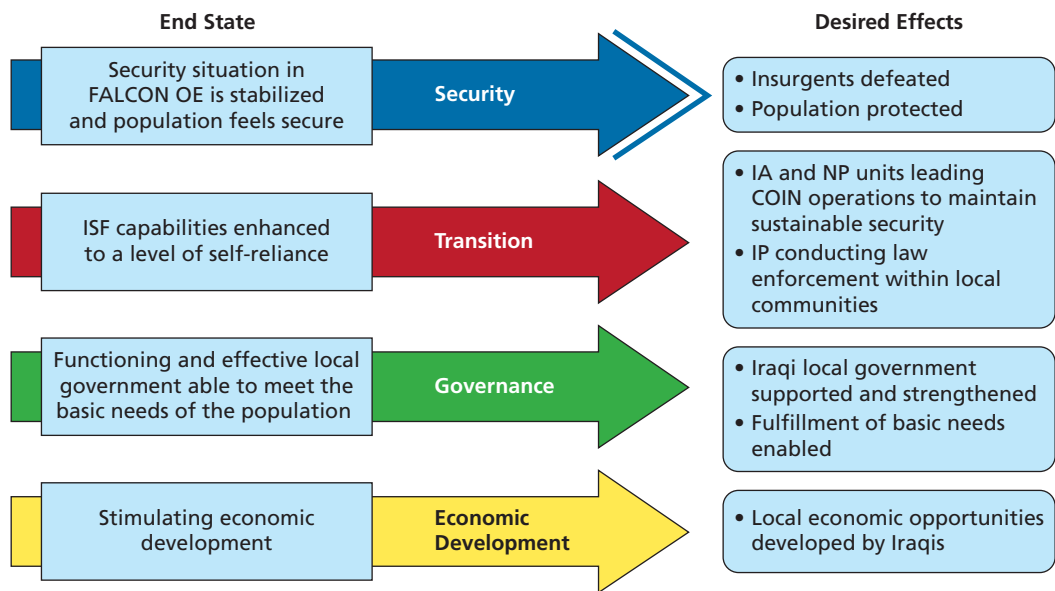

SOURCE: Farris, "Warfighter Observations During the Surge."

RAND RR160-2.3

Protecting contested neighborhoods also essentially fixed key insurgent nodes in place, facilitating the task of killing or capturing insurgents, because attempting to pass through U.S. and Iraqi checkpoints substantially increased their risk of capture (Figure 2.5). Evading those checkpoints was very difficult, and the attempt to do so immediately identified one as a person of interest. Meanwhile, technical intelligence, much of it provided from U.S. national assets, helped identify and locate key insurgent leaders. In order to successfully exploit intelligence about fleeting, time-sensitive targets, 2-82 BCT's companies had to be able to launch a platoon-sized raid on thirty minutes' notice. To respond this quickly, companies needed to have ready access to relevant information, which meant that virtually every company needed classified digital communications enabled by tactical Secure Internet Protocol Router Network (SIPRNet). BCTs only have enough equipment to provide that level of capability to their subordinate battalion headquarters. 2-82 BCT, as did other units in Iraq, required considerable augmentation to operate effectively.<sup>7</sup> Exploiting this intelligence, U.S. forces could conduct targeted raids to kill or capture insurgent leaders, disabling and dismantling their networks.<sup>8</sup> In the face of these targeted raids, Shia extremist leaders began to take

<sup>7</sup> Major Gina Thomas, telephone interview with M. Wade Markel, February 24, 2010.

<sup>8</sup> Farris interview. Farris and others whom we interviewed stressed the vital importance of this technical intelligence in identifying and apprehending insurgents. General Hammond, Major Bryan Gibby, the 3-4 BCT

**Figure 2.4**  
**Fighting with Concrete: 2-82 BCT T-Walls**

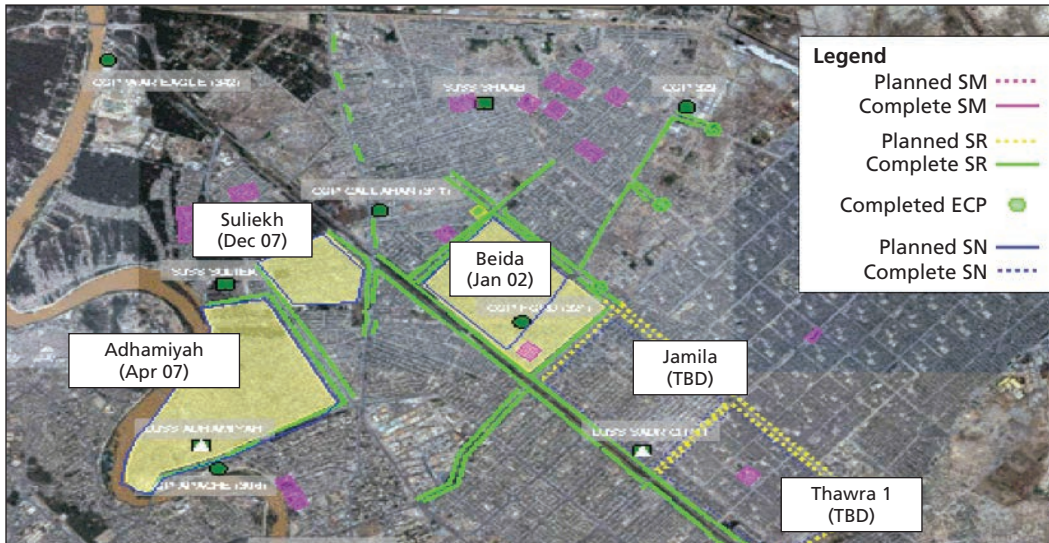

SOURCE: Farris, "Warfighter Observations During the Surge."

NOTES: SM = secure market. SR = secure route. ECP = checkpoint. SN = secure neighborhood. Jamila and Thawra 1 are the two neighborhoods below Sadr City that will become key in the coming battle.

RAND RR160-2.4

refuge in the relative sanctuary of Sadr City. Still, getting "information to the objective" remained an issue. Units below company had to call back to higher headquarters to get information they could not receive directly, e.g., UAS intelligence regarding enemy activity near the objective. This obviously caused delays and created risk.

Beginning in the late summer of 2007, Farris began employing these methods against centers of Shia extremism, focusing initially on Shaab.<sup>9</sup> 2-82 BCT relied very heavily on technical intelligence, since JAM's dominance of the area of operations essentially precluded human intelligence. Initially, special operations forces conducted most of the raids. In time, however, JAM learned to muster large response forces using Sadr City's ubiquitous loudspeakers, generating forces that could well have overwhelmed a platoon. In one particularly brutal encounter in October 2007, special operations forces had to call for air support to avoid being overrun. That skirmish left at least thirty Iraqis dead, many of whom were probably noncombatants. Thereafter, the al-Maliki government dramatically curtailed U.S. access to Sadr City. On the U.S.

---

intelligence officer, and Lieutenant Colonel Barry Graham, the MND-B G-2, all asserted that reliable human intelligence from inside of Sadr City was nearly impossible to obtain.

<sup>9</sup> Major Bryan Gibby, comments on draft. Shaab is another district of Baghdad to the northwest of Sadr City. Figure 3.9 depicts it more clearly.

**Figure 2.5**  
**2-82 BCT Soldiers Patrolling in Baghdad**



SOURCE: Staff Sergeant Martin K. Newton, U.S. Army.

RAND RR160-2.5

side, 2-82 BCT began conducting raids in at least company strength in order to overawe potential attackers.<sup>10</sup>

2-82 BCT's resulting concept of operations envisioned isolating Sadr City and then loosening JAM's hold on its population through a combination of targeted kinetic and nonkinetic initiatives. The objective was to set the conditions for the Iraqi government to resolve its standoff with al-Sadr politically, and under favorable terms. Major General Hammond, whose 4th Infantry Division replaced the 1st Cavalry Division as MND-B on December 19, 2007, believed the essential tasks in this shift were to isolate Sadr City, influence its population, then employ Iraqi security forces (ISF) to stabilize the district. Isolating Sadr City would prevent JAM from increasing its strength and capabilities. Hammond intended to isolate Sadr City by emplacing joint security stations along the major avenues of ingress and egress at five or six locations. Targeted raids, combined with targeted information operations, would erode JAM's capabilities and its ability to control the population. Focused civil-military operations would increase the government of Iraq's legitimacy and attractiveness relative to JAM's. The

---

<sup>10</sup> Farris interview.



focus at this point would be on enhancing the Iraqi government's legitimacy, not that of coalition forces.<sup>11</sup>

While the concept started with U.S. actions, it depended on the Iraqi government developing the capability to hold and administer what had been gained. Above all, Iraqi forces had to develop the capability to protect the population. The fundamental assumption underlying this concept was that Sadr City's population had grown weary of JAM domination after four years of experience with it. Hammond himself had noticed a marked decline in popular enthusiasm toward JAM from his last tour of duty in Baghdad three years earlier.<sup>12</sup>

During 2-82 BCT's fifteen months in Iraq, violent incidents dropped by 70 percent. It also accomplished the following in its lines of operations:

- Security:
  - Killed and captured over 1,200 insurgents
  - Established four joint security stations (JSSs) and six combat outposts (COPs)
  - Emplaced over 49 kilometers of concrete barriers to create multiple "Safe Communities"
  - Trained and employed 3,000 Concerned Local Citizens (CLCs)
  - Isolated the strategic terrain of Sadr City
- Transition:
  - Significantly developed two Iraqi Security Force Brigades
  - Established a functional police force in Adhamiyah
- Governance:
  - All Neighborhood Advisory Councils (NACs) fully functional in Adhamiyah
  - Mixed Sunni/Shia Adhamiyah District Advisory Council (DAC) rejoined the political process
- Economic: Establishment of numerous "Safe Markets" initiatives appreciably enhanced economic development and lowered unemployment<sup>13</sup>

2-82 BCT turned responsibility for the area of operations over to 3rd Brigade Combat Team, 4th Infantry Division (3-4 BCT) on March 15, 2008. The conditions under which the Battle of Sadr City would be fought were largely set.

---

<sup>11</sup> Lieutenant Colonel Gerard Messmer, telephone conversation with M. Wade Markel, November 9, 2010. Cited hereafter as "Messmer comments on draft, November 9, 2010."

<sup>12</sup> Major General Jeffery Hammond, interview with David E. Johnson and M. Wade Markel, Fort McPherson, Georgia, February 25, 2010; Colonel Jim Rainey, interview with M. Wade Markel and Brian Shannon, Fort Carson, Colorado, January 11, 2010; Lieutenant Colonel Gerald Messmer, former head of MND-B's civil military operations section, telephone interview with M. Wade Markel, April 26, 2010.

<sup>13</sup> Farris, "Warfighter Observations During the Surge."

## Summary and Conclusion

In this chapter we described how U.S. forces, particularly Colonel Billy Don Farris's 2-82 BCT, evolved a concept of operations for controlling an urban insurgency. The centerpiece to that concept of operation was isolating an area of operations with concrete T-walls, thereby controlling access. Access control enabled U.S. forces to set the tempo of operations and methodically capture or kill insurgent leaders through targeted raids. The inability to provide raiding forces with video feeds of raid targets proved to be a significant impediment, though not a critical one. Those methods helped quell the Sunni insurgency, allowing Multi-National Force–Iraq (MNF-I) and the al-Maliki government to turn their attention to Shia challengers to the government's authority. By the fall of 2007, U.S. forces had begun applying those techniques to JAM in Sadr City. The government of Iraq's policy also shaped the battle, in that it prevented ground maneuver forces from going north of Route Gold. Those efforts shaped the conditions under which the battle was fought.



## Conditions on the Eve of the Battle of Sadr City

---

The battle took place in a particular strategic and operational context that shaped the outcome. As described in the last chapter, the implementation of the Baghdad Security Plan largely neutralized the Sunni insurgency in Baghdad, allowing the government of Iraq and the coalition to turn their attention to the Shia militias, especially Moqtada al-Sadr's Jaish al-Mahdi. Indeed, the al-Maliki government's impending offensive in Basra probably provoked the Battle of Sadr City. Geographically, Sadr City's sheer size and population limited U.S. options for neutralizing JAM. From the outset, it was clear that MND-B lacked the forces to clear Sadr City block by block, or provide for its 1.6 to 2.4 million inhabitants should intense fighting displace them. On the other hand, Sadr City's low buildings, flat terrain, and absence of vegetation created favorable conditions for aerial observation and strike. Moreover, JAM's conduct over the past several years had done much to reduce its popular support. 2-82 BCT's operations against JAM in Sadr City had killed or captured several of its leaders and forced others to flee Baghdad, degrading JAM's command and control capability for the coming battle. On the U.S. side, the units that would fight in Sadr City were familiarizing themselves with the area of operations. Serendipitously, those units had emphasized traditional combat operations in pre-deployment training. Iraqi forces still suffered from glaring weaknesses, but had reached the point where they could become capable with just a little more effort. On balance, the correlation of forces favored the United States on the eve of the battle.

### Political and Strategic Context

By March 2008, implementation of the Baghdad Security Plan had achieved several results that set conditions for the battle in Sadr City. First, al-Qaeda in Iraq had been badly hurt and its ability to create mass-casualty events significantly reduced. Through the end of 2007, the 4th Infantry Division and its predecessor as MND-B, the 1st Cavalry Division, had concentrated on neutralizing al-Qaeda in Iraq (AQI) in Baghdad. By January 2008, Major General Jeffery Hammond, the 4th Infantry Division's commander, considered that mission largely accomplished. AQI had been defeated in

Baghdad, its networks dismantled and its agenda thoroughly discredited.<sup>1</sup> This allowed coalition forces to turn their attention to other destabilizing elements, such as the Sadrist movement. Figure 3.1 shows the significant reduction in the number of attacks in Baghdad between March 2007 and February 2008.

Second, the Baghdad Security Plan had significantly strengthened the al-Maliki government's position, enabling it to survive a rupture with the Sadrists. Indeed, Prime Minister al-Maliki was moving to confront the Sadrist militias in Basra, and preparations were well under way by March 2008. Third, coalition forces had mostly contained JAM, the Sadrists' armed militia, to Sadr City, a circumstance that would severely constrain JAM's capabilities in the coming battle.

There was, however, one notable exception to the trend of decreasing levels of violence in Baghdad: Sadr City. Although MND-B had begun to isolate Sadr City to some degree, within its boundaries the militantly anti-American JAM firmly controlled the population. Although SOF and conventional force raids against JAM leadership had resulted in the capture, death, or flight out of Iraq of much of the senior JAM leadership, the raids had also caused significant tension between the government of Iraq and JAM. Importantly, U.S. activity in Sadr City had largely ceased in October 2007 in the aftermath of an air strike that killed a number of Iraqi civilians. Prime Minister al-Maliki placed Sadr City off limits to U.S. ground operations. JAM's firm control of

**Figure 3.1**  
**Attacks in Baghdad**

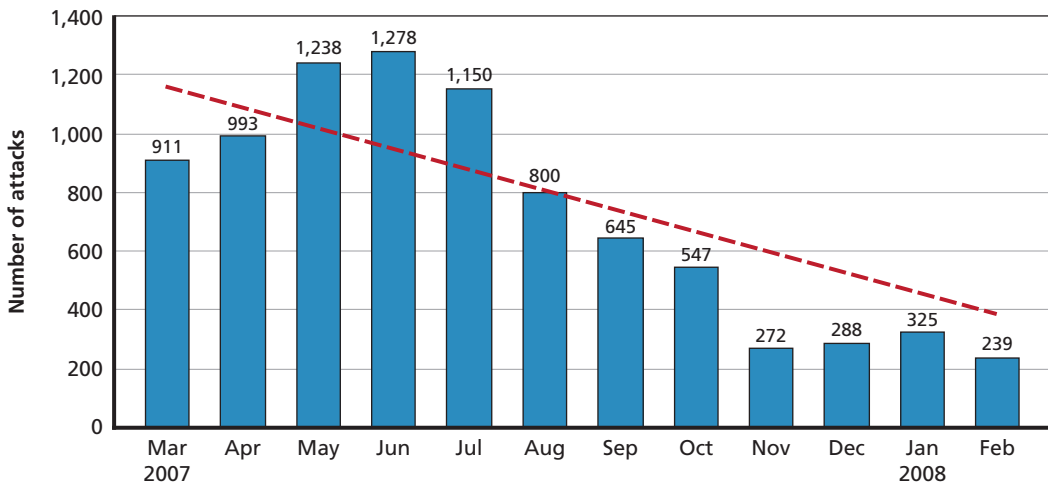

SOURCE: Multi-National Division–Baghdad, "Fort Hood Community Leaders VTC, 25 April 2008," briefing, April 25, 2008.

RAND RR160-3.1

<sup>1</sup> Hammond interview.

the population had already severely limited U.S. awareness of what was going on inside Sadr City. After October 2007, U.S. forces, with the exception of technical intelligence means, were more or less blind when it came to the JAM stronghold.<sup>2</sup>

The remainder of this chapter will describe the state of Iraqi political conditions, Sadr City's physical and human terrain, JAM, Iraqi security forces, and U.S. forces on the eve of the Battle of Sadr City.

By January 2008 the government of Prime Minister al-Maliki was headed for a physical confrontation with al-Sadr's JAM. Al-Maliki's preparations and troop movements toward Basra for an offensive against JAM in that Sadrist stronghold probably sparked the Sadr City battle. JAM, the Islamic Supreme Council of Iraq's Badr Corps, and the locally powerful Fadhil militias waged a low-grade civil war with each other for control of Basra. The al-Maliki government came to believe that it could no longer afford to surrender control of Iraq's second-largest city and maintain its credibility, so it started to move toward confrontation in early 2008. Neither al-Maliki nor his subordinates made any secret of their intentions.<sup>3</sup>

Al-Sadr withdrew his political support from the al-Maliki government in January 2008.<sup>4</sup> At the time, al-Sadr and JAM were at the apogee of their power and influence, and were likely unwilling to make further political compromise with al-Maliki. By withdrawing their support for al-Maliki, JAM forfeited the effective shield that the al-Maliki government had been providing against the U.S. desire to go after the militia.

## Physical and Human Terrain

Sadr City occupies the northeast corner of Baghdad. Figure 3.2 shows its location relative to the rest of the city. It lies east of the Tigris River and sits between the Army Canal and another canal that rings Baghdad to the north. Sadr City was established in 1958 to provide housing to Baghdad's largely Shia population of migrants looking for work.

Sadr City is a tightly packed area, arranged in a grid of streets and alleys around neighborhoods (*mujallahs*) consisting mainly of three-story or lower buildings. Figures 3.3 and 3.4 show representative pictures of Sadr City buildings and a typical alleyway.

<sup>2</sup> Colonel John Hort, interview with David E. Johnson and M. Wade Markel, Carlisle Barracks, Pennsylvania, November 5, 2010.

<sup>3</sup> See "Iraq's Basra Police Chief Says Plan Drawn Up to Eliminate Militias," British Broadcasting Service, March 15, 2008; Kim Sengupta, "The Final Battle for Basra Is Near, Says Iraqi General," *The Independent*, March 20, 2008.

<sup>4</sup> International Crisis Group, *Iraq's Civil War, the Sadrists and the Surge*, Middle East Report No. 72, February 7, 2008, p. 14. Hereafter cited as "International Crisis Group, *The Sadrists and the Surge*."

**Figure 3.2**  
**Baghdad and Sadr City**

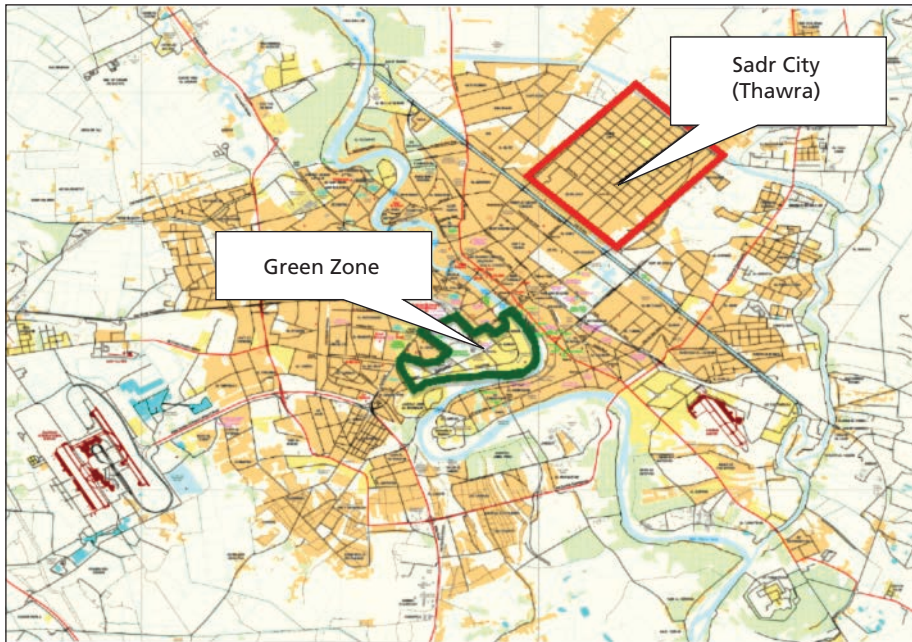

SOURCE: National Geospatial Intelligence Agency, "Baghdad," Edition 2, February 10, 2006.  
 RAND RR160-3.2

With their relatively uniform height and easily accessed rooftops, Sadr City's buildings provided convenient avenues of approach and egress to Sadrist militiamen, and an opportunity to ambush U.S. forces from a position of advantage. The advantages of urban terrain, however, did not accrue entirely to one side. There are neither trees nor urban canyons to conceal JAM's activity from aerial observation and attack, and the city's rooftops are easily observed and engaged from the air.

The streets in Sadr City are laid out in a grid pattern, with broad, straight thoroughfares surrounding neighborhoods with an interior grid of narrow alleys. Before the battle, piles of trash lined the streets, providing ample concealment for IEDs. The major north-south thoroughfares point like spears toward the international zone. Many of these small, cluttered alleys significantly restricted vehicle movement, especially Stryker armored vehicles with their width and large turning radius.

Sadr City is divided into three main districts, as shown in Figure 3.5: Ishbiliyah; Habbibiyah, a relatively prosperous area that includes the Jamiliyah Market, one of Baghdad's biggest; and Sadr City proper.<sup>5</sup> Ishbiliyah and Habbibiyah are south of Al-

<sup>5</sup> This description simplifies Sadr City's geography to facilitate description of the battle and subsequent activities. Formally, what was called "Sadr City" was actually Thawra, which consisted of eight or nine subdivisions.

**Figure 3.3**  
**Sadr City Buildings**

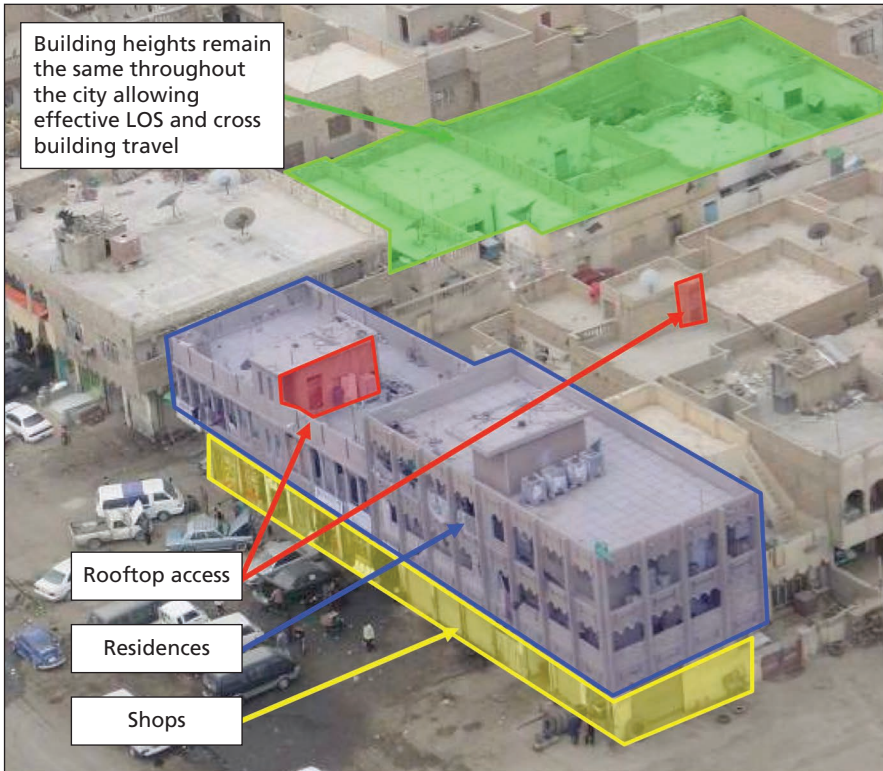

SOURCE: Adapted from briefings, C Company, 1st Squadron, 2nd Stryker Cavalry Regiment, c. 2007–2008.

NOTE: LOS = line of sight.

RAND RR160-3.3

Quds Street, the major terrain feature separating Habbibiyah and Ishbiliyah from Sadr City proper. Several open areas, often school soccer fields, provide suitable launch sites for rockets. Most of the intense ground combat took place in Habbibiyah and Ishbiliyah, the area to which U.S. forces referred as Operational Environment (OE) Gold. Figure 3.5 depicts OE Gold in relation to Sadr City. Figure 3.5 also gives some sense of the constrictive terrain of OE Gold and shows that it was a relatively small portion of the Sadr City district.

Sadr City packed almost one-fifth of Baghdad's population into its narrow confines. Many of Sadr City's estimated 2.4 million inhabitants were impoverished and disenfranchised. In 2007, the date of the last authoritative survey, 19 percent of Sadr City's children were moderately or severely stunted from malnutrition. At the time of the battle, male unemployment reportedly stood at 16 percent. Two-thirds of Sadr



**Figure 3.4**  
**Sadr City Alleyway**

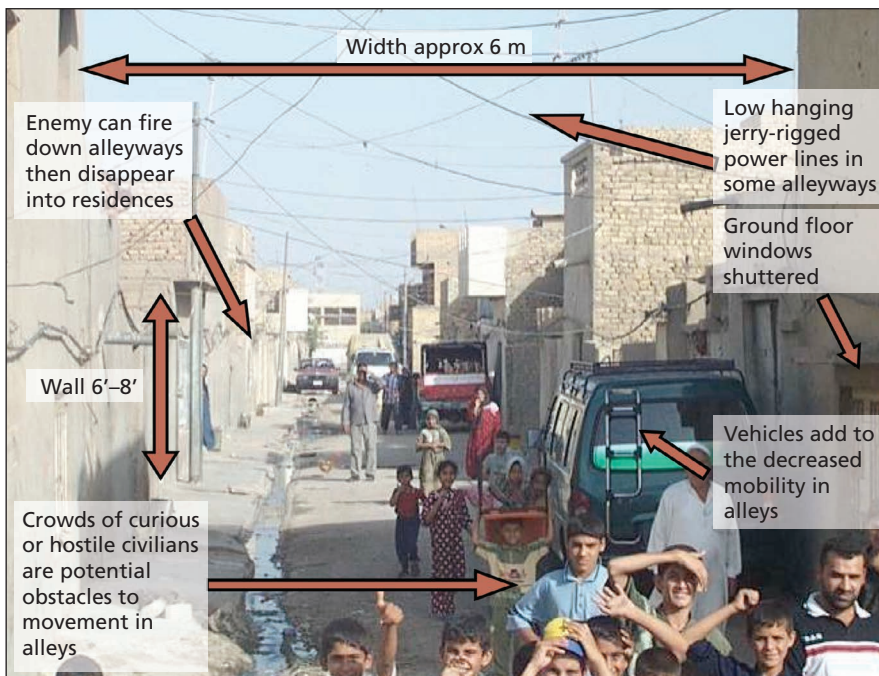

SOURCE: Adapted from briefings, C Company, 1st Squadron, 2nd Stryker Cavalry Regiment, c. 2007–2008.

RAND RR160-3.4

City’s households either lacked electricity or experienced more than eleven hours of blackouts per day.<sup>6</sup>

The picture was not, however, uniformly bleak. According to several U.S. officers, there were neighborhoods within Sadr City as prosperous as any in Iraq. Habbibiyah in particular was relatively comfortable, at least compared to the rest of Baghdad. Though sectarian violence had forced many Sunnis to move out of Sadr City, others had lived in Habbibiyah before the war, and several Sunni mosques remained there.<sup>7</sup> Many officials in the new Shia-dominated government lived there as well.

<sup>6</sup> Estimates of Sadr City’s population vary widely. The last major outside survey of Sadr City’s population was the World Food Program’s *Comprehensive Food Security and Vulnerability Analysis in Iraq*, Baghdad: World Food Program, 2008, p. 108. The World Food Program’s Iraq Office conducted the study in 2007. Contemporary U.S. military sources place the figure at nearer 2.4 million. See Headquarters, 3rd Brigade, 4th Infantry Division, “Operation Iraqi Freedom: December 2007–March 2009,” April 2009. Major Bryan Gibby, telephone interview with M. Wade Markel, January 27, 2010.

<sup>7</sup> Headquarters, 1st Squadron, 2nd Cavalry Regiment (Stryker), “Sadr City,” briefing, undated.

**Figure 3.5**  
Operational Environment Gold in Relation to Sadr City

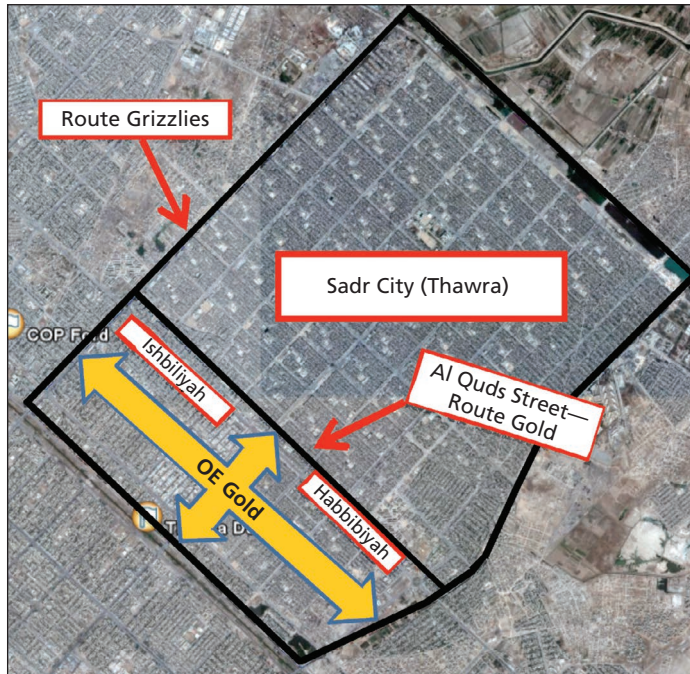

SOURCE: Adapted from briefings, C Company, 1st Squadron, 2nd Stryker Cavalry Regiment, c. 2007–2008.

RAND RR160-3.5

## The Combatants

### Jaish al-Mahdi

JAM was the paramilitary wing of the Sadrist Trend, Moqtada al-Sadr's national political movement. JAM was mostly a franchise operation, nationally integrated in support of al-Sadr's political program, but locally owned and operated. Association with al-Sadr provided local groups legitimacy and the ability to coordinate programs and actions. In turn, local factions provided al-Sadr with nationwide reach and a broad base of support. Local affiliates focused mainly on controlling their own turf, however. In fact, according to Lieutenant Colonel Barry Graham, the 4th Infantry Division's intelligence officer at the time of the battle, different factions operating under JAM's black banners often competed for the same areas, sometimes violently.<sup>8</sup> Anything that threatened local JAM leaders' grip on their turf threatened their status, revenue, and personal security. Thus while al-Sadr might choose to defer confrontation with coali-

<sup>8</sup> Lieutenant Colonel Barry Graham, interview with M. Wade Markel, the Pentagon, January 19, 2010.

tion forces until a more propitious time, local JAM leaders could not afford that level of discretion. As it happened, Sadr City's JAM leaders proved willing to fight to nearly the last militia member to retain their grip on the district.

According to Major Bryan Gibby, 3-4 BCT's intelligence officer, JAM had organized Sadr City into 80 sectors. Figure 3.6 shows a typical sector.

Each sector was organized around its mosque, its school, and its own militia group. Within these sectors, JAM adjudicated disputes, administered justice, and provided essential services. JAM grouped these sectors into four "bands," each of which ran the length of Sadr City, including the corresponding parts of Ishbiliyah and Habbibiyah.<sup>9</sup>

Al-Sadr often found it useful to assert that he could not control militia elements claiming allegiance to him. He found this expedient when their actions aroused condemnation, but the assertion contained a grain of truth as well. As will be shown, local affiliates seemed to respond to national direction, but only when obedience did not conflict with their own objectives.<sup>10</sup>

**Figure 3.6**  
**Typical Sadr City Sector**

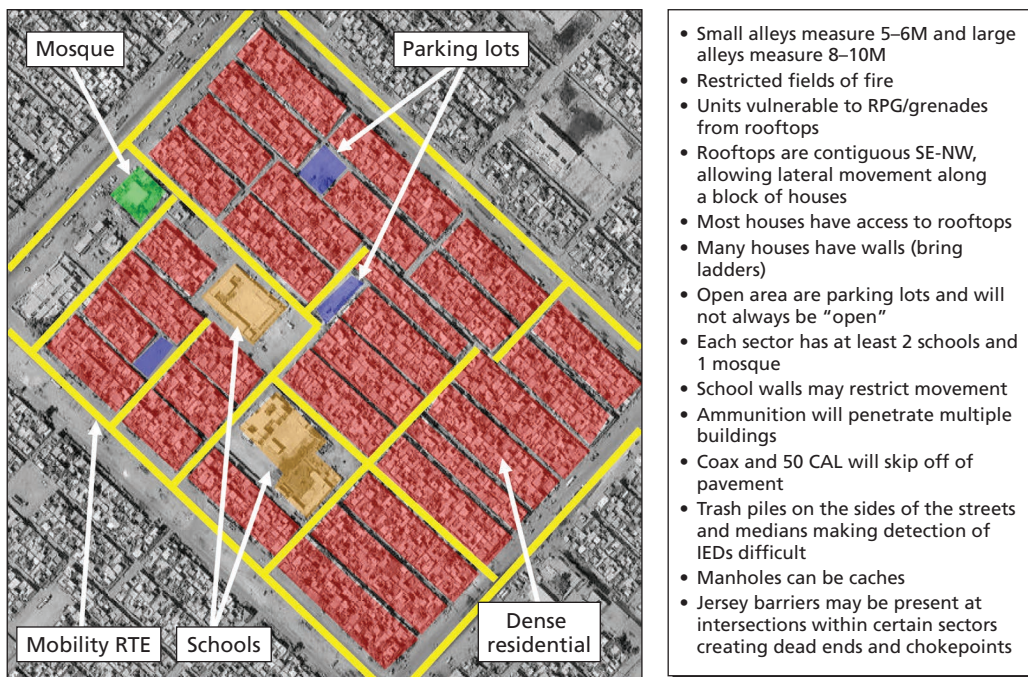

SOURCE: Adapted from briefings, C Company, 1st Squadron, 2nd Stryker Cavalry Regiment, c. 2007–2008.  
NOTE: RTE = route; alley measurements are the widths of the alleys.

RAND RR160-3.6

<sup>9</sup> Gibby interview; Major Bryan Gibby, comments on draft narrative, November 2, 2010.

<sup>10</sup> International Crisis Group, *The Sadrists and the Surge*.

In contrast to the regular JAM, JAM's "Special Groups" were thought to be considerably more independent of local imperatives and more responsive to national-level direction. The Special Groups benefited from Iranian support and training. U.S. military officials in Iraq accused the Iranian Revolutionary Guard Corps's Quds Force, an organization analogous to U.S. Special Forces, of providing JAM Special Groups with training in Iran: "They were being taught how to use EFPs (explosively-formed penetrators), mortars, rockets, as well as intelligence, sniper, and kidnapping operations."<sup>11</sup> Colonel John Hort, commander of 3-4 BCT, noted that there were also "Hezbollah in Iraq" snipers, using Steyr .50 caliber sniper rifles.<sup>12</sup> Captain Jon Bradford, who commanded Company B, 1st Squadron, 2nd Stryker Cavalry Regiment (B/1-2 SCR), remembered JAM's mortar fire as being particularly accurate.<sup>13</sup> During their attacks on the International Zone, JAM rocket teams demonstrated the capability to hit specific targets and adjust their fire based on intelligence about target effects. This indirect-fire capability constituted their main offensive capability. Attacks on government forces near Shia areas was something the government could ignore; rocket attacks on the Green Zone were provocations to which the government of Iraq would have to respond.

JAM exhibited all the weaknesses of an organization that had grown too fast. Its rank and file were aggressive and easily provoked, but the U.S. focus on the Sunni insurgency had spared the militia the winnowing of combat against a capable opponent. Ethnic-cleansing operations against Sunni noncombatants did not provide an adequate substitute for such experience. American soldiers who fought JAM forces in Sadr City observed that they were highly motivated, but not particularly capable. Marksmanship was poor, and small groups lacked the ability to maneuver under fire.<sup>14</sup> What they lacked in competence they made up for in confidence, however, and they initially achieved moral ascendancy over Iraqi security forces in the fight for Sadr City.

Neither JAM nor the so-called Special Groups demonstrated particularly sophisticated cyber or electronic warfare capabilities during the battle. They were never able to jam U.S. communications or "hack" into either the Predator or Shadow UAVs' flight controls. In these respects, JAM was probably less capable than future hybrid or irregular opponents are likely to be.

It is important, however, not to exaggerate the distinction between JAM proper and its component Special Groups. It proved useful to al-Sadr, the government of Iraq, and to the United States to maintain that those elements attacking the Green Zone

---

<sup>11</sup> "US Links Iran to Attack in Iraq," *BBC News*, July 2, 2007. See also International Crisis Group, *The Sadrist and the Surge*, p. 16, and Cochrane, p. 4.

<sup>12</sup> Colonel John Hort, interview with David E. Johnson and M. Wade Markel, November 5, 2010.

<sup>13</sup> Major Jonathan Bradford, interview with M. Wade Markel, the Pentagon, July 9, 2010.

<sup>14</sup> Bradford interview. Colonel Mike Pappal, telephone interview with David E. Johnson, M. Wade Markel, and Brian Shannon, July 2, 2010. Command Sergeant Major Steve Lewis, telephone interview with M. Wade Markel, July 28, 2010.

and Iraqi security forces were rogue elements, i.e., Special Groups of JAM, rather than the executors of JAM policy. The view of many of the U.S. participants in the battle is that this is a distinction without a difference. JAM and the Special Groups shared many of the same leaders and followers.<sup>15</sup> Ordinary JAM militia and Special Group elements frequently fought together, and there was a degree of coordination between rocket attacks and ground maneuver. There was little difference between the two as far as coalition forces were concerned.<sup>16</sup>

At the battle's outset, JAM held Sadr City's inhabitants in a strong grip. Moqtada's father, the Grand Ayatollah Mohammed Sadiq al-Sadr, had earned their devotion with a program of social outreach and spiritual renewal that he had launched in the 1990s. The district became known as Sadr City after Saddam Hussein had Mohammed Sadiq assassinated. Moqtada assumed his father's role as the voice and protector of Iraq's Shia underclass.<sup>17</sup>

Most residents needed help, and what help they got came from Moqtada al-Sadr's militia, the JAM. Up until the battle itself, JAM had been the only entity providing public order, security, and essential services within Sadr City. U.S. forces had controlled Sadr City briefly in the wake of al-Sadr's 2004 uprising, but lacked the forces to hold what they had taken when confronted with more pressing challenges elsewhere.<sup>18</sup> To the extent that the legitimate government of Iraq had established any presence in Sadr City at all, al-Sadr's people had thoroughly infiltrated that presence, to the point that any government efforts were actually seen as JAM's doing. Sadr City's residents credited JAM with any improvements in their standard of living.<sup>19</sup>

JAM's grip on the Sadr City populace, however, was perhaps not as firm as outsiders might have supposed. Its services came at the price of violence, corruption, intimidation, and brazen criminality. Furthermore, JAM was as likely to attack rival Shia factions or Sunnis as it was to fight coalition forces. JAM financed its activities through quasi-legitimate operations (like their network of petrol stations), over which they had an effective monopoly and on which ordinary Iraqis depended for life's necessities, and selling electric power from microgeneration. JAM also collected protection money from Shia merchants in their communities. JAM directed much of its criminal

---

<sup>15</sup> Marisa Cochrane, *Special Groups Regenerate: Summer 2007–Summer 2008*, Washington, D.C.: Institute for the Study of War, 2008, p. 4. See also Amit R. Paley, "U.S. Deploys a Purpose-Driven Distinction; Reluctance to Identify Foes as Sadrists Reflects View of Iran and Fragility of Security Gains," *The Washington Post*, May 21, 2008, p. A8.

<sup>16</sup> Gibby, comments on draft.

<sup>17</sup> Cockburn, pp. 98–106.

<sup>18</sup> Peter Chiarelli and Patrick Michaelis, "Winning the Peace: The Requirement for Full-Spectrum Operations," *Military Review*, July/August 2005, pp. 4–14.

<sup>19</sup> Damien Cave et al., "Assessing the 'Surge': A Survey of Baghdad Neighborhoods," *The New York Times*, September 6, 2007.

activity at Baghdad's Sunni communities; one particularly shocking practice was to murder someone and then ransom the victim's remains to his or her relatives. While this loot and these levies funded essential services, the public suspected that JAM leaders skimmed a lot off the top. Individual JAM members became increasingly brutal, arrogant, and capricious. Most of Sadr City's inhabitants adhered to JAM for the same reason that new inmates join prison gangs: sheer survival.<sup>20</sup>

After the battle began, for whatever reason, the volume of reliable intelligence received by U.S. and Iraqi units from Sadr City's inhabitants increased dramatically. Captain Jason Northrop, commander of Company C, 1st Squadron, 2nd Stryker Cavalry Regiment (C/1-2 SCR), which was responsible for Habbibiyah and Ishbiliyah from the fall of 2007 through the battle's early stages, noted that the sheer amount of intelligence was more than his command post or the 1-2 SCR's operations center could process. Northrop recalled that nearly all the tips about IED locations were either confirmed or believed to be plausible. He remembers returning to his squadron's tactical operations center (TOC) one day and reporting the IEDs he encountered en route. The intelligence analyst pulled one pushpin marking a reported IED location after another from the situation map as he rendered his report. The squadron headquarters had simply been unable to process these reports fast enough to warn his unit because of the high call volume.<sup>21</sup>

### **Iraqi Security Forces**

The security forces at al-Maliki's disposal were imperfect instruments. Although MNF-I had spent considerable effort organizing, training, and equipping the Iraqi Army, the Iraqis still lacked extensive combat experience and, hence, confidence in themselves. U.S. officials publicly conceded that the Iraqi Army's combat support and logistical capabilities were rudimentary at best. U.S. officers described the Iraqi Army before Sadr City as a "checkpoint Army." That is, the Iraqi Army had accustomed itself to static security missions, not maneuver. Discipline was indifferent, exhibited by erratic conformity to uniform standards and by poorly prepared positions. A typical checkpoint is shown in Figure 3.7. Our respondents' assessments were consistent with those of contemporary observers, most notably the Independent Commission on the Security Forces of Iraq headed by retired General James Jones. The Commission's report noted that

---

<sup>20</sup> Major General Jeffrey Talley, interview with M. Wade Markel, Dallas, Texas, June 2, 2010; International Crisis Group, *The Sadrists and the Surge*, p. 14.

<sup>21</sup> Captain Jason Northrop, interview with David E. Johnson and M. Wade Markel, Arlington, Virginia, March 16, 2011.

**Figure 3.7**  
**Iraqi Army Checkpoint**



SOURCE: Provided to the authors by the 4th Infantry Division.

RAND RR160-3.7

The challenge for the [Iraqi] Army is its limited operational effectiveness, caused primarily by deficiencies in leadership, lack of disciplinary standards and logistics shortfalls.<sup>22</sup>

Senior Iraqi commanders closely managed platoon-level operations using specially trained, handpicked units. They seldom employed all or even most of their battalions or brigades simultaneously, except in static security missions. While most Iraqi staff officers struck their U.S. counterparts as reasonably competent and reliable, staff planning and coordination seldom occurred. Colonels were loath to delegate any important function to their subordinates, lest they be held accountable for their subordinates' failings.<sup>23</sup> In the coming battle, officers leading Iraqi forces committed to the battle either overcame these shortcomings or were replaced.

---

<sup>22</sup> James L. Jones, *Report of the Independent Commission on the Security Forces of Iraq*, September 6, 2007, p. 9. See also Anthony Cordesman and Samantha Lomeli, *Iraqi Force Development: A Progress Report*, Washington, D.C.: Center for Strategic and International Studies, 2007, pp. 39–41.

<sup>23</sup> Hort interview; Major Brian North, interview with M. Wade Markel and Brian Shannon, Fort Carson, Colorado, January 12, 2010 (North led 3rd Brigade, 4th Infantry Division's internal MiTT [Military Training Team] to the 42nd Iraqi Army Brigade); Lieutenant Colonel Mike Pemrick, interview with M. Wade Markel, Fort Belvoir, Virginia, February 26, 2010 (Pemrick had been the brigade's deputy commander, with a primary focus on

The competence problems of the Iraqi security forces were exacerbated by another important factor: divided loyalties. According to Omar al-Shahery, a former intelligence official in the Iraqi Ministry of Defense, key commanders were Sadrists, including the commander of the 6th (Baghdad) Division. Before the split between the government and al-Sadr, the government removed commanders who had carried out successful operations against JAM. Sadrists had thoroughly infiltrated the Ministry of Interior and the National Police. According to Captain Northrop, whose company (C/1-2 SCR) was responsible for Habbibiyah and Ishbilyah from about August 2007 through the start of the battle, the local police commander was thoroughly corrupt and deliberately ineffective.<sup>24</sup> While the Iraqi security force capabilities were uncertain, their motivation was an even greater source of uncertainty.<sup>25</sup>

### U.S. Forces

On the eve of the Battle of Sadr City, MND-B had at its disposal some 31,000 U.S. soldiers, including six U.S. brigade combat teams and three additional brigade-sized enabler units. The disposition of the six U.S. maneuver brigades is shown in Figure 3.8. Iraqi forces in Baghdad included three Iraqi Army divisions (26,000+ troops), two national police divisions (22,000+ troops), the Sons of Iraq militia (32,000+ troops), and the Iraqi police (20,000+ troops).<sup>26</sup>

3-4 BCT would be responsible for the prosecution of operations in Sadr City. Geographically, however, Sadr City proper occupied only a relatively small portion of 3-4 BCT's area of operations, as shown in Figure 3.9.

Figure 3.10 shows the overall multinational chain of command in Iraq at the time, including Iraqi security forces units that ultimately became involved in the Battle of Sadr City.<sup>27</sup> Figure 3.11 depicts the units assigned to 3-4 BCT in June 2008.

3-4 BCT was operating with two maneuver battalions east of the Army Canal, and another to the canal's west. It did not have its reconnaissance squadron. Figure 3.12 depicts their disposition at the onset of the battle. 1-2 SCR, commanded by Lieutenant Colonel Dan Barnett, was responsible for all of Sadr City and Ur, the uninhabited shantytown directly to its west. The 1st Combined Arms Battalion, 68th

---

improving Iraqi Army capabilities); Major General Jeffery Hammond, interview with David E. Johnson and M. Wade Markel, Fort McPherson, Georgia, February 25, 2010.

<sup>24</sup> Northrop interview.

<sup>25</sup> Omar al-Shahery, written responses to questions, June 4, 2010.

<sup>26</sup> Multi-National Division–Baghdad, "Fort Hood Community Leaders VTC, 25 April 2008." U.S. maneuver brigades included the 1st Squadron, 2nd SCR; the 2nd BCT, 25th Infantry Division; the 2nd BCT, 101st Airborne Division, the 4th BCT, 10th Mountain Division; the 1st BCT, 4th Infantry Division; and the 3rd BCT, 4th Infantry Division.

<sup>27</sup> The lines of authority shown in the figure are not as clear as the organization chart portrays. Specifically, by 2008 al-Maliki had effectively centralized control of the Iraqi security forces under himself, and the Ministry of Defense was largely powerless.



**Figure 3.8**  
**Disposition of MND-B Maneuver Brigades**

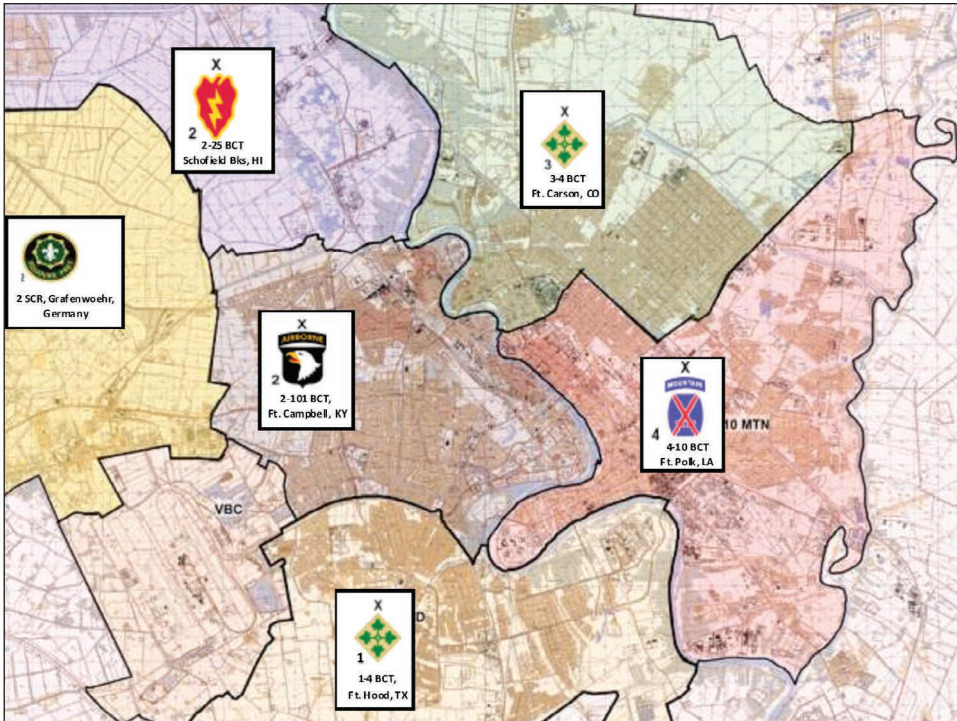

SOURCE: Multi-National Division–Baghdad, “Fort Hood Community Leaders VTC, 25 April 2008.”  
 RAND RR160-3.8

Armored Regiment (TF 1-68 CAB), commanded by Lieutenant Colonel Mike Pappal, was responsible for a vast battlespace that included Shaab (west of Ur) and the more rural area north of Baghdad in which the principal municipality was Husseiniyah.<sup>28</sup>

**Pre-Deployment Training: Getting Ready for a Fight**

The battalion-level units that would operate under 3-4 BCT had trained for the sort of fighting they would encounter in the coming Battle of Sadr City during preparations for deployment. Their commanders had chosen to do so in spite of the prevailing assumption that the likelihood of intense combat operations in Iraq was low, based on their own independent analysis of the operational environment. Indeed, Major Kurt Thompson, battalion operations officer (S-3) of 1-2 SCR during the fighting, remem-

<sup>28</sup> Hort interview; Headquarters, 3rd Brigade, 4th Infantry Division, “Operation Iraqi Freedom: December 2007–March 2009,” briefing, April 29, 2009.

**Figure 3.9**  
**3-4 BCT's Area of Operations**

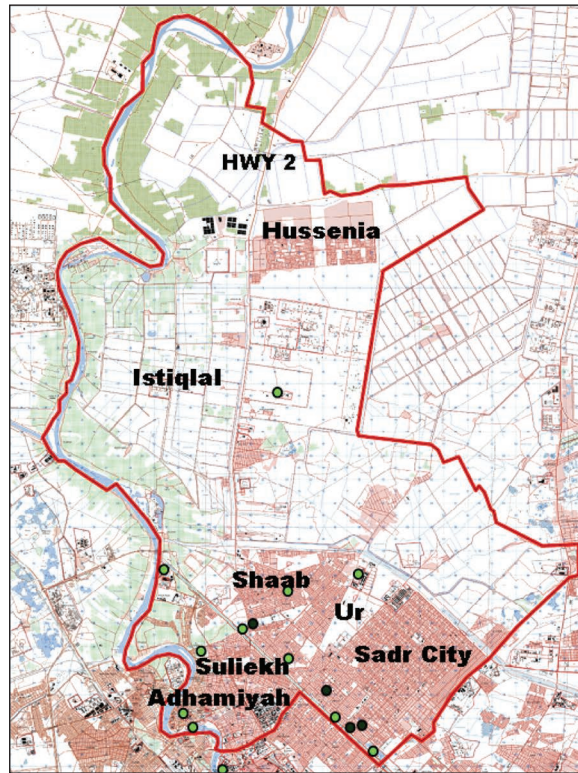

SOURCE: 3rd Brigade Combat Team, 4th Infantry Division, "Operation Iraqi Freedom, December 2007–March 2009."

RAND RR160-3.9

bers being told that "you're not going into a fight" in the course of preparations for deployment.<sup>29</sup>

1-2 SCR had prepared to serve as an operational reserve during its tour in Iraq. Because of the unit's high mobility, relative protection, and fairly plentiful complements of dismounted infantry soldiers, Multi-National Corps–Iraq (MNC-I) commanders had frequently employed Stryker brigades in roles that emphasized crisis response and combat. Therefore, 1-2 SCR focused on traditional combat missions during its preparations.<sup>30</sup>

The TF 1-68 CAB's directed training had emphasized counterinsurgency (COIN). Colonel Pappal also insisted on vigorous preparation for combat operations. Captain

<sup>29</sup> Major Kurt Thompson, telephone interviews with M. Wade Markel, January 6–7, 2011.

<sup>30</sup> Lieutenant Colonel Chris Keller, interview with M. Wade Markel, Arlington, Virginia, August 4, 2010.

**Figure 3.10**  
**The Multinational Chain of Command and Iraqi Security Forces**  
**in the 2008 Battle of Sadr City**

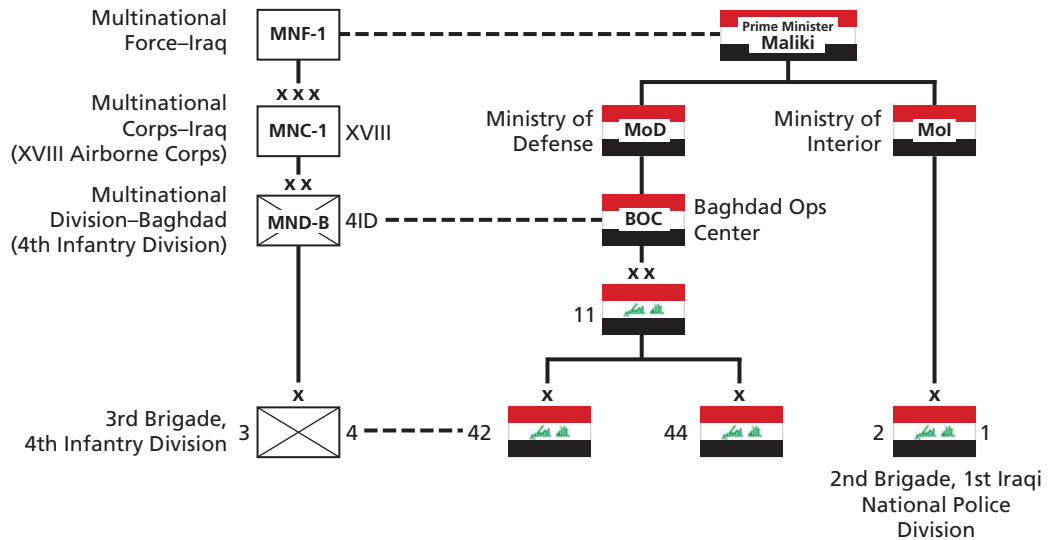

SOURCE: Adapted from 3rd Brigade Combat Team, 4th Infantry Division, "Operation Iraqi Freedom, December 2007–March 2009," briefing, 2009.

NOTE: Dashed lines indicate coordination; solid lines command.

RAND RR160-3.10

**Figure 3.11**  
**3-4 BCT Task Organization as of June 2008**

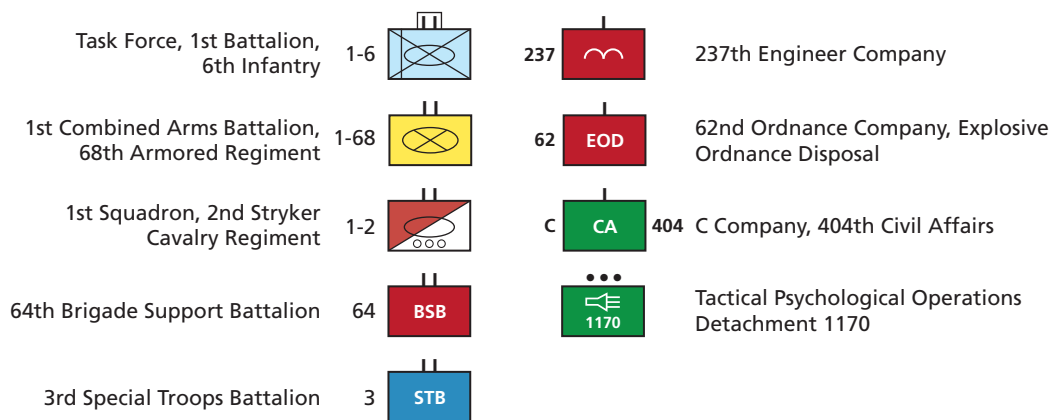

SOURCE: Adapted from 3rd Brigade Combat Team, 4th Infantry Division, "Operation Iraqi Freedom, December 2007–March 2009."

NOTE: The task organization of 3-4 BCT changed during the battle; this is what it was at the battle's end.

RAND RR160-3.11

**Figure 3.12**  
**3-4 BCT Dispositions as of March 15, 2008**



SOURCE: Headquarters, 3rd Brigade, 4th Infantry Division, "Operation Iraqi Freedom: December 2007–March 2009," April 29, 2009.

NOTE: These and other figures with unit designations are snapshots of the dispositions at a specific point in time.

RAND RR160-3.12

Todd Looney, who commanded one of Pappal's company teams, made sure to conduct tank gunnery qualification training (Tank Table VIII) before the battalion deployed to Iraq. Looney also did a live-fire exercise with up-armored HMMWVs (high mobility multipurpose wheeled vehicles) to prepare for the high probability that his unit would be operating in them instead of their tanks. When he spoke with us, Looney emphasized that he did not separate stability operations training from combat operations training because he did not feel that the two could be separated in the COIN environment. Indeed, Colonel Pappal insisted on integrated training for all his subordinate companies. For example, he would have units train on engaging with local civilians as part of consolidation and reorganization, as opposed to a separate activity.<sup>31</sup>

Lieutenant Colonel Brian Eifler's Task Force 1st Battalion, 6th Infantry Regiment (TF 1-6 IN) had prepared equally for combat and COIN operations at the insistence of its brigade commander, Colonel Pat White. White knew that Eifler's task force would deploy separately from his brigade combat team (1st BCT, 1st Armored Division). No one knew where it would go or what its mission would be. For that reason,

<sup>31</sup> Pappal interview; Major Todd Looney, telephone interview with M. Wade Markel and Brian Shannon, April 29, 2010.

White insisted that TF 1-6 be prepared for anything. He had Eifler organize his two mechanized infantry and one armored companies as three mixed infantry-armor teams. Eifler also constituted company intelligence fusion cells organized around each team's fire support team.<sup>32</sup>

The brigade support battalion (BSB) commanded by then Lieutenant Colonel Robert Hatcher underwent similarly demanding training. Hatcher anticipated having to sustain brigade elements in an insecure area of operations. His concept of a deliberate combat logistics patrol informed his training program. As its name suggests, Hatcher's battalion organized and conducted logistics missions first and foremost as combat patrols. Accordingly, the BSB's soldiers participated in advanced rifle marksmanship training, including close quarters drills. During the convoy live-fire exercise, Hatcher made his troops dismount and engage targets from the ground. Physical training was non-negotiable. Hatcher was sure his soldiers would have to fight, and he wanted them to be able to do so. Their training required considerably more resources than that normally afforded logistics units in peacetime, however.<sup>33</sup>

Training was not as thorough for some of the other supporting units, however. Sergeant Corey Collings of the Virginia Army National Guard's 237th Engineer Company remembers training for his unit's route clearance mission in an old commercial utility cargo vehicle (CUCV) with a hole cut in the top to replicate an MRAP. A similarly aged five-ton truck with a jury-rigged mechanical arm stood in for a Buffalo route clearance vehicle. Even then, mission-oriented training constituted only a fraction of his company's post-mobilization training, most of which was consumed with validating individual and small unit training the unit had completed before mobilization.<sup>34</sup>

Fortunately for the 237th, the unit retained considerable combat experience from its previous deployment, which had spanned from the end of 2004 to the beginning of 2006. According to Collings, all but one of his unit's squad leaders were veterans of that deployment. Moreover, the Virginia National Guard's sniper instructors had provided valuable pre-mobilization training in spotting IEDs. The snipers taught the engineers scanning techniques that enabled them to identify the subtle disturbances in normal patterns that indicated roadside bombs, even in Iraq's ubiquitous trash. Throughout its deployment, the 237th demonstrated an uncanny ability to spot IEDs, and would not lose a single soldier to mines.<sup>35</sup>

The aforementioned battalion commanders all made the decision to increase their emphasis on traditional combat operations more or less independently. Certainly Pappal and Hatcher reflected Colonel Hort's intention, but 1-2 SCR's Barnett and

---

<sup>32</sup> Lieutenant Colonel Brian Eifler, telephone interview with M. Wade Markel, April 26, 2010. His former operations officer, Kurt Thompson, also provided input.

<sup>33</sup> Colonel Bob Hatcher, email to David E. Johnson, October 26, 2011.

<sup>34</sup> Sergeant Corey Collings, telephone interview with M. Wade Markel, February 9, 2012.

<sup>35</sup> Collings interview.

TF 1-6 IN's Eifler reported to different commanders. There was more than chance behind their decisions. Those decisions reflected individual commanders' independent assessments of the potential requirements of the military situation. Lacking a point of comparison, it is difficult to assess the precise degree to which these preparations contributed to a successful outcome. On balance, however, it seems plausible that this pre-deployment emphasis on traditional combat operations did contribute to a relatively successful outcome.<sup>36</sup>

### **The COIN Academy: Emphasizing Restraint**

Multi-National Force–Iraq's COIN Academy challenged the assumptions on which such training was based. The COIN Academy was established by General George Casey, when he was the commander of MNF-I, to help deploying commanders make the cognitive transition from traditional combat to COIN.<sup>37</sup> The cadre at the COIN Academy duly impressed incoming unit commanders with the importance of acting within FM 3-24's emphasis on limiting violence. Those limitations are best expressed in one of FM 3-24's "paradoxes": "Sometimes doing nothing is the best reaction." Instructors showed image after image of bomb, missile, and indirect-fire strikes that had gone off target and caused collateral damage. They stressed that collateral damage had serious consequences for U.S. objectives in Iraq—and the careers of the commanders who authorized them. According to Captain Northrop, who attended the COIN Academy with the rest of 1-2 SCR's key leaders, the COIN Academy "scared the bejesus out of them."<sup>38</sup>

There was standoff between JAM and 3-4 BCT when the latter assumed responsibility for Sadr City and the surrounding areas. Colonel Pappal subsequently characterized the contest as stalemated. JAM had a strong presence in Husseiniyah to the north, and had fairly tight control over the population in Shaab. Captain Bradford, whose B/1-2 SCR was responsible for Ur, noted that the people living on the margins in his area of operations avoided taking sides, but allowed JAM unmolested transit.<sup>39</sup>

---

<sup>36</sup> We should also acknowledge that units probably had to de-emphasize other aspects of training in order to increase their emphasis on traditional combat operations. With regard to 1-2 SCR, that tradeoff was explicit, according to Chris Keller, the former squadron executive officer. The unit did not anticipate being responsible for a specific area of operations, and thus deemphasized training for stability operations in support of local populations. Other commanders we interviewed did not concede any reduction in emphasis on COIN and stability operations tasks, however.

<sup>37</sup> For the circumstances of the COIN Academy's foundation, see David H. Ucko, *The New Counterinsurgency Era: Transforming the U.S. Military for Modern Wars*, Washington, D.C., Georgetown University Press, 2009, pp. 76–77, and Austin Long, *Doctrine of Eternal Recurrence: The U.S. Military and Counterinsurgency Doctrine, 1960–1970 and 2003–2006*, Santa Monica, Calif.: RAND Corporation, 2008.

<sup>38</sup> Northrop interview.

<sup>39</sup> Bradford interview; Pappal interview.

In Ishbilyah and Habbibiyah, the southern portions of Sadr City, the rest of 1-2 SCR executed a daily rhythm of counterinsurgency operations. During the day, some key squadron leaders would engage with local notables, while the rest would spread out on patrols to make contact with the population and support various civic action projects in an attempt to secure the local inhabitants' allegiance. Route clearance patrols would criss-cross the sector, occasionally finding IEDs. More often, those patrols simply added to the American "presence" in the zone.<sup>40</sup> Finally, leaders from the BSB's deliberate combat logistics patrols would also collect information en route, then debrief the intelligence session extensively afterward.<sup>41</sup>

At night, squadron elements would conduct raids into Sadr City to kill or capture insurgents. They would also support Joint Special Operations Command (JSOC) operations based on the intelligence they had gained during the day and on intelligence gleaned from other sources. 2-82 BCT's Colonel Farris referred to these two aspects of counterinsurgency as the "day job" and the "night job," terms that his successors in 3-4 BCT would continue to use. Progress was at best slow, and there was always a good chance that combat would erupt. TF 1-68 CAB lost two soldiers to an EFP (explosively formed penetrator) sometime around March 18, 2008, and direct-fire engagements were not infrequent.<sup>42</sup> Aside from a general aversion to U.S. occupation, the population was wary of reprisals for being seen to communicate or cooperate with Americans.<sup>43</sup>

U.S. forces became habituated to this routine. It did not seem to affect soldiers' mindsets very much at the squad and section level. They were already accustomed to the unpredictable alternation between engaging the population in dialogue and the enemy with direct fire. But the routine of counterinsurgency, and the heavy emphasis on restraint and avoiding collateral damage, may have affected intermediate leaders' mindsets. Prior to the first deliberate attacks into Ishbilyah and Habbibiyah after the battle, Brigadier General Grimsley postponed the attack because he felt junior leaders were not mentally ready.<sup>44</sup>

There is also little evidence of a marked decay in skills for traditional combat. Unit leaders were aware of useful capabilities and how to employ them. For example, after receiving the operations order to seize the primary rocket point of origin in Ishbilyah, Captain Bradford asked General Grimsley for a mine clearing line charge (MICLIC) launcher. Grimsley commended Bradford on his judgment but had to inform him

---

<sup>40</sup> Collings interview.

<sup>41</sup> Hatcher email, 2011.

<sup>42</sup> Captain Clint Rausch, telephone interview with David E. Johnson and M. Wade Markel, September 23, 2010. Northrop interview.

<sup>43</sup> Bradford interview; Keller interview; Colonel Dan Barnett, comments on draft, dated November 30, 2010.

<sup>44</sup> The reader should remember that most of the division's leaders were "junior" as far as Grimsley was concerned.

that there were none to be had in Iraq.<sup>45</sup> Soldiers and units proved able to employ all the weapon systems they did have with reasonable effectiveness in the particular operational context. 3-4 BCT units did not employ their mortars or tube artillery due to concerns about collateral damage. Moreover, the enemy did not possess the kind of capability that would have truly tested soldiers' skills. Ergo, there is little basis for assessing the degree to which skills had or had not atrophied with regard to combined arms maneuver in an urban setting.

Mid-level leaders' mindsets do seem to have limited the materiel and organizational capabilities immediately available to units on the ground. C/1-68 CAB had trained for the battle it would face on March 23, 2008. Readers may recall that Captain Todd Looney had made his platoons conduct mounted live-fire exercises in up-armored HMMWVs during pre-deployment training. Looney's company would have been even better prepared if it had been operating in its tanks. Those tanks were parked back at Taji, however, lest they "send the wrong message."<sup>46</sup> Captain Northrop had left his company's Stryker 120mm mortar carrier vehicles at Camp Taji for wholesale refit because they weren't using them.<sup>47</sup> These materiel shortcomings reflected a mindset about the kind of fight U.S. forces had been engaged in for years in Iraq: COIN operations that placed a premium on low collateral damage to avoid alienating the population. In Sadr City, the character of the fight was about to change.

## A Change in Context

In late February, the engineers got a foreshadowing of what was to come. In the middle of another route clearance and presence patrol, a lone militiaman jumped into the middle of the street and fired a belt of ammunition at them. Through dumb luck, the militiaman wound up in a gap in the patrol's fields of fire, and disappeared as suddenly as he had come. Because of his poor marksmanship, no one in the patrol was hurt, either.

A little later, the patrol spotted what appeared to be an IED in an old brake drum. In this situation, the patrol leader would have the Buffalo approach the IED directly and disarm it using its arm. The direct approach usually had the Buffalo moving at a 45° angle to the line of march. For some reason, the driver first drove up on the sidewalk, a 90° turn from the direction of march. This allowed the patrol to spot an EFP in the storm drain between the Buffalo's original position and the decoy IED. Beneath that EFP lay other powerful explosives, which they discovered when they detonated

---

<sup>45</sup> Bradford interview.

<sup>46</sup> Looney interview.

<sup>47</sup> Northrop interview.



the EFP. The men of the patrol felt that someone had set the trap very carefully to exploit their standard operating procedures.

The patrol encountered increasingly intense combat from that point forward. After clearing the EFP, the engineers turned around and headed northwest on the same route. By that time, the engineers had linked up with a section of explosive ordnance disposal (EOD) troops and a Stryker platoon. This small task force now consisted of the route clearance patrol, four Stryker armored vehicles, and five up-armored HMMWVs. The 237th's commander was in charge, and also controlled two AH-64 helicopters overhead. When the force reached the intersection of their road and Route Delta, the main thoroughfare bisecting Sadr City, someone spotted an EFP on one of the intersection's four corners. The EOD team initiated a controlled detonation on the EFP, then dismounted to collect forensic evidence. Immediately, they spotted other EFPs on the intersection's other corners. Before they could do anything, however, small arms fire erupted from all sides. The Americans returned fire. The fight grew so intense that some of the Strykers ran out of ammunition for the .50 caliber machine guns in their remote weapons system. Adding to the confusion, a U.S. mortar platoon fired illumination rounds, temporarily negating the U.S. advantage in night-vision capabilities. Then, just as suddenly as it began, the fight ended.

Later, when Collings's platoon returned to JSS Sadr City to regroup, key members in the platoon conducted an after action review. Out of all the day's unusual violence, the one thing that stood out in their memories was the lone gunman with his RPK machine gun. Collings's platoon sergeant summed it up for them: "It wasn't an attack, and it wasn't an ambush. It was a message."

## Summary and Conclusions

On balance, the strategic and operational context favored U.S. forces and their Iraqi allies on the eve of the Battle of Sadr City. The "surge" had mostly neutralized the Sunni insurgency in Baghdad, allowing the al-Maliki government and MND-B to focus on the government's Shia rivals. Meanwhile, JAM's own behavior had eroded its support among Sadr City's population. Serendipitously, the U.S. battalions that would fight in Iraq had trained for high-intensity combat during their pre-deployment training. U.S. raids against JAM leaders had disrupted their networks and degraded their command and control capabilities. Though it was not apparent at the time, the Iraqi Army was very close to being able to conduct operations on its own. Sadr City's sheer size and population would limit U.S. options in the coming battle, but its particular brand of urban terrain provided very favorable conditions for the employment of aerial intelligence, surveillance, and reconnaissance and strike. Fortunately, only a portion of the district was within 107mm rocket range of the Green Zone. When the rocket attacks began on March 23, however, that restricted zone was all JAM needed.

## The Battle Begins

---

On March 23, JAM launched a coordinated offensive against government positions and the Green Zone. It seems likely, however, that JAM was trying to forestall the government's offensive in Basra. The Sadr City attacks preceded the government's offensive in Basra by two days, government officials having declared that they would launch their Basra offensive very soon. Preparations clearly indicated that they were not bluffing. JAM apparently believed that attacks in the capital would force the government to return its focus and forces to Baghdad, thus discrediting the al-Maliki government. Besides the apparent logic of the situation, militia members told *Washington Post* reporters at the time that that was their objective.<sup>1</sup>

U.S. commanders had not expected this counteroffensive. For that matter, they seemed to have discounted the possibility that the al-Maliki government would actually carry out its Basra offensive, which precipitated the Battle of Sadr City. Nevertheless, they adapted quickly. Concepts of operation evolved over time, but always included two key elements: controlling rocket launch sites in Ishbilyah and Habbibiyah with ground maneuver forces, and neutralizing those beyond Route Gold with aerial strike and intelligence, surveillance, and reconnaissance (ISR). Controlling the launch sites in Ishbilyah and Habbibiyah proved difficult, forcing U.S. commanders to keep adding more forces in support of the combat taking place there. By the end of this part of the battle, U.S. and Iraqi forces held Sadr City up to Route Gold. Their ability to do so under more or less continuous JAM attacks was in doubt, however.

### JAM's Initial Onslaught

On March 23, JAM launched a coordinated offensive throughout Baghdad. For 3-4 BCT, although fighting was most intense in Sadr City, it was not confined to that area. Indeed, 3-4 BCT found itself engaged not only in Sadr City, but throughout its area of operations (shown earlier in Figure 3.12). Key areas included: Ur, an unincorporated

---

<sup>1</sup> Sudarsan Raghavan, "19 Tense Hours in Sadr City Alongside the Mahdi Army; After Calm Year, Fighting Engulfs Shiite Enclave," *The Washington Post*, March 29, 2008, p. A1.

shantytown; Shaab, another of Baghdad's largely Shia enclaves; and Istiql Qada, a mostly undeveloped district several kilometers to Sadr City's north whose largest urban center is Husseiniya.

The offensive seemed to focus on the government of Iraq and was apparently intended to highlight its inability to provide security. A barrage of rockets, mostly from Sadr City, struck the Green Zone. The map in Figure 4.1 shows the location and size of Sadr City, as well as two of the key routes (Gold and Grizzlies). It also shows how close Sadr City is to the Green Zone. From the neighborhoods south of Route Gold, JAM 107mm rockets could hit the Green Zone.

Concurrent with the rocket attacks, JAM began attacking Iraqi security forces and seizing their checkpoints. The U.S. headquarters at Camp Victory received mortar fire. Major Chris Keller, 1-2 SCR executive officer, could see explosions and smoke all around Sadr City's perimeter from the top of the old Iraqi Ministry of Defense (MoD) building. The Iraqi Army's 44th Brigade, then responsible for checkpoints within Sadr City, as well as the National Police brigade, which maintained the checkpoints on its outskirts, essentially collapsed. Iraqi forces often abandoned these checkpoints with-

**Figure 4.1**  
**Map of Baghdad and Sadr City**

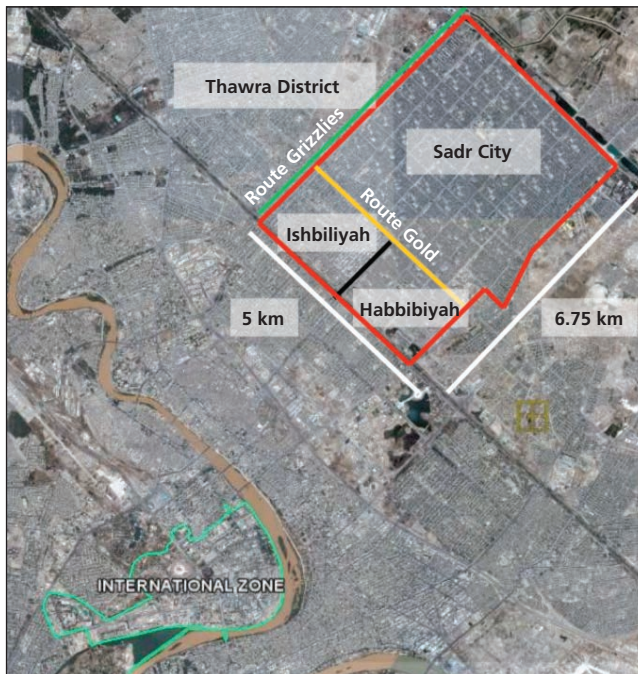

SOURCE: Adapted from briefings, C Company, 1st Squadron, 2nd Stryker Cavalry Regiment, c. 2007–2008.

RAND RR160-4.1

out a fight, either from fear of JAM or clandestine fealty to it.<sup>2</sup> In the neighboring 4th Brigade, 10th Mountain Division (4-10 BCT) sector, “all hell broke loose.”<sup>3</sup> Overall, the offensive’s timing, scope, and coordination indicated substantial preparation and premeditation.

JAM demonstrated varying levels of capability during its offensive. The attacks were well coordinated, both in relation to one another and with regard to their actual conduct. Furthermore, JAM seems to have prepared at least rudimentary engagement areas. The rocket attacks against the Green Zone demonstrated the capability to adjust fires accurately based on intelligence, though the source of that targeting intelligence was never discovered. 120mm mortar fires were particularly accurate, described by Captain Bradford as “dialed in.” JAM also employed some more sophisticated weapons, including SA-7 man-portable air-defense systems.

That said, JAM had several key deficiencies. Its small arms fire was seldom accurate, and the enemy demonstrated little ability to maneuver and press the attack. First Sergeant Steve Lewis, C/1-2 SCR, believed that the enemy was very determined but not very skilled. Captain Northrop recalls that JAM fighters would often rush out into the middle of the street to engage U.S. forces, including armored vehicles, with small arms. Captain Kyle Morse, who led C/1-2 SCR’s 2nd Platoon, later stated that the enemy couldn’t be said to have employed small-unit tactics at all. Colonel Pappal, who had fought JAM and other insurgent organizations in 2003, thought their capabilities had declined significantly since then.<sup>4</sup> Figure 4.2 shows SCR soldiers and a Stryker vehicle; Figure 4.3 shows soldiers on patrol in Sadr City.

## Stopping JAM

U.S. and some Iraqi commanders worked feverishly to stabilize the situation following the JAM attacks. Highly competent U.S. small units and considerable junior commander initiative was key to these efforts. One example was Captain Bradford’s reaction to a report from the Iraqi officer in charge of the checkpoint at the northwest corner of Sadr City that he was being overrun. Bradford later determined through a UAS flight that the Iraqis had abandoned the checkpoint. Nevertheless, Bradford organized a platoon attack to retake the checkpoint.<sup>5</sup>

Upon arrival at the checkpoint, the platoon found no one there. Within an hour, however, they started receiving intense small arms, RPG, and 82mm mortar

---

<sup>2</sup> Keller interview; North interview; Pemrick interview.

<sup>3</sup> Lieutenant Colonel Robert S. Ballagh III, interview with M. Wade Markel, the Pentagon, February 8, 2011.

<sup>4</sup> Bradford interview. Major Jason Northrop, written response to questionnaire, August 14, 2010. Captain Kyle Morse, telephone interview with M. Wade Markel, July 6, 2010. Lewis interview; Pappal interview.

<sup>5</sup> Bradford interview.

**Figure 4.2**  
**1-2 SCR Soldiers and a Stryker Vehicle**



SOURCE: Sergeant First Class Christina Bhatti, U.S. Army.

RAND RR160-4.2

fire. The mortar fire was extremely accurate. One round struck a Stryker vehicle in the vulnerable spot between the remote weapons system (RWS) and the commander's cupola, killing the vehicle commander. The enemy did not, however, attempt to maneuver on the platoon's position. They were firing from the three- or four-story buildings in Sadr City down on to the U.S. positions located in the flimsy shantytown buildings in Ur. Bradford's platoon suppressed the enemy effectively using the .50 caliber machine guns in the remote weapons systems. They also called in AH-64 Apache attack helicopters, which employed their Hellfire missiles to attack targets within Sadr City. U.S. fires were still very restricted at this point. Bradford requested permission to attack into Sadr City proper several times, but his squadron headquarters denied his request, probably because Sadr City proper remained off limits to U.S. forces.<sup>6</sup>

Back at the 1-2 SCR tactical operations center (TOC) in the old MoD building, Major Keller was fully consumed supporting B Company's battle at the checkpoint. The TOC coordinated airborne reconnaissance from the BCT's Shadow and Predator UASs supporting the brigade.<sup>7</sup> It also coordinated attack helicopter support. Because

<sup>6</sup> Bradford interview.

<sup>7</sup> According to Keller, while Predator support, especially armed Predator support, would increase dramatically in the coming days, they had become accustomed to employing Predators in the months prior to the battle.

**Figure 4.3**  
**Sadr City Patrol**



SOURCE: Sergeant First Class Christina Bhatti, U.S. Army.  
RAND RR160-4.3

the companies lacked the capability to receive video feeds directly from the Shadow UASs, the TOC had to relay what TOC personnel were seeing using voice communications. While the preferred mode of operation was to have observers from the unit in contact direct the attack helicopter engagements, the squadron TOC also had to direct the air weapons teams (AWTs) to the target when those targets were within the restricted area of Sadr City. They had gotten used to this procedure in the preceding months, but the intensity of this battle was nearly overwhelming. Supporting B Company fully consumed the TOC's human and material capacity. Fortunately, Colonel Barnett had similar capabilities in his tactical command post (TAC) and was able to help coordinate support for C Company.<sup>8</sup>

Intense fighting continued for several days. Captain Northrop, C/1-2 SCR, later wrote:

<sup>8</sup> Keller interview. In comments on a draft of this narrative, Bryan Gibby noted that Colonel Hort eventually concluded that the tiny video terminals used at the battalion level impeded effective kinetic engagements, and subsequently reserved the authority to launch missiles based on video feeds to the brigade.

They [the enemy] used anything and everything to barrier streets, and they began to put IEDs [improvised explosive devices] everywhere. I ordered the platoons to shoot anything that looked like an IED with a .50 cal. burst. The platoons' longest period without shooting something was twenty minutes. It was like being in an arcade game. Everything that could have been an IED was. The air was full of automatic weapons fire, mortars, Molotov cocktails and RPGs [rocket-propelled grenades].<sup>9</sup>

Captain Todd Looney, commanding C/1-68 CAB, started receiving similar reports of checkpoints under attack at about the same time. On a map, it looked as if the enemy was working its way down the western side of Sadr City. Looney dispatched a platoon to reinforce the checkpoint that seemed to be next in line. That checkpoint was just west of the intersection of routes Gold and Grizzlies. Though C/1-68 was nominally an armor unit, it was operating in up-armored HMMWVs at the time. The platoon arrived just as the checkpoint came under fierce attack. It reported receiving intense small arms, heavy machine gun, and rocket-propelled grenade fire from a nearby apartment building located inside Sadr City. Looney decided to reinforce that position with a second platoon, and requested permission to seize the enemy position. Sadr City proper, however, still remained off limits to U.S. forces. Therefore, C Company's platoons were only able to return fire, but succeeded in suppressing the enemy in about an hour. To Looney, the attack seemed larger, more determined, and better organized than anything he had experienced in Iraq to that point.<sup>10</sup>

The experience at one Iraqi Army checkpoint illustrates the complex and treacherous political and security dynamics underlying the battle in microcosm. It further illustrates the state of the Iraqi Army and U.S. leaders' role in mentoring it. Lieutenant Colonel Mike Pemrick, 3-4 BCT's deputy brigade commander, and his security detail were checking Iraqi positions that night. Pemrick encountered an Iraq battalion commander on a checkpoint at the edge of Sadr City. Most of the Iraqi commander's men had abandoned the position and their chief, who was getting ready to abandon the position as well. Pemrick stayed with the Iraqi commander until the latter had settled down a bit. While he was there, they heard small arms fire and an IED explosion. The Iraqi battalion commander thought that his own men had emplaced the IED.<sup>11</sup> As this incident shows, Iraqi commanders did not trust their men, often with reason. This level of distrust and the lack of mutual confidence made Iraqi Army units somewhat fragile.

Fighting erupted on Sadr City's outskirts simultaneously, with uprisings in Shaab, Subak Sur, and Husseiniya in the TF 1-68 CAB's area of operations. JAM attacked the

---

<sup>9</sup> Captain Jason Northrop, email to John Northrop. Neither Northrop can remember the exact date of the email, but it was toward the beginning of the fight.

<sup>10</sup> Looney interview. Headquarters, TF 1-68 AR, *TF 1-68 History: Operation Lion Firestorm*, p. 2. Colonel Mike Pappal, comments on draft, December 22, 2010.

<sup>11</sup> Pemrick interview.

National Police station in Shaab, but the police managed to hold them off with U.S. support. Similar attacks were taking place throughout the TF 1-68 CAB's area. Iraqi police checkpoints were coming under attack throughout Shaab and Ur. For the most part, the Iraqi National Police in Shaab held out fairly well, reinforced by TF 1-68 CAB elements and some Sons of Iraq that TF 1-68 CAB mobilized. Their performance confirmed Lieutenant Colonel Pappal's assessment that this Iraqi National Police unit was one of the better battalions in the force. JAM elements also ambushed TF 1-68 CAB patrols, though the ambushes were not very effective.<sup>12</sup>

Elements of the 237th Engineer Company were caught up in one such ambush. On the night of March 26, Corey Collings's platoon was returning from a mission north of Husseiniya. As they approached an Iraqi checkpoint, they noticed that all of the Iraqis manning the checkpoint clambered back into their armored vehicles. Almost immediately thereafter, an IED disabled the patrol's Husky vehicle and initiated an ambush. The platoon started taking fire from the outskirts of Husseiniya. Collings was manning the Gyrocam in his RG-31 Medium Mine Protected Vehicle (MMPV) at the time. The Gyrocam was a stabilized camera system on a 28-foot mount, with daylight video, infrared video, and thermal sights. That night, its most important feature was its infrared spotlight, which Collings had modified to serve as an infrared laser designator. Collings used the Gyrocam to designate targets for other platoon weapon systems and the Apaches that showed up overhead. Figure 4.4 shows the Gyrocam mounted on Collings's RG-31.<sup>13</sup>

Faced with this effective fire, the ambushers retreated into Husseiniya. The AH-64s kept them under observation, however. When the ambush party regrouped in an open space, the helicopters fired two Hellfire missiles into the party. The aviators later estimated they had killed between twelve and fourteen enemy combatants.<sup>14</sup>

Perhaps most significantly, this fighting involved the 42nd Brigade of the Iraqi Army, led by "Brigadier General X."<sup>15</sup> The National Police battalion manning the checkpoints in his sector also happened to fall under X's command. When those checkpoints came under attack, he started reinforcing police checkpoints with his own better-trained and -equipped forces. Brigadier General X also began coordination with the 44th Brigade, which was responsible for Sadr City proper, all to buttress his own position. Brigadier General X's actions are important in that they were the first effective Iraqi response taken in response to the JAM offensive, and, importantly, they were taken at his own initiative.<sup>16</sup>

<sup>12</sup> TF 1-68 AR, *Lion Firestorm*, p. 2. Pappal interview.

<sup>13</sup> Collings interview.

<sup>14</sup> Collings interview.

<sup>15</sup> We use "Brigadier General X" to protect this Iraqi officer's identity. At the time the battle commenced, he was actually a colonel.

<sup>16</sup> North interview.



**Figure 4.4**  
**RG-31 with Gyrocam**



SOURCE: Sergeant Corey Collings. Then PFC Collings stands third from the left.

RAND RR160-4.4

Unsurprisingly, U.S. leaders' appreciation of the situation was much clearer in retrospect than it was at the time. It took several days for American commanders to realize that a major battle was under way. JAM was firing rockets at the Green Zone, but it had done that before. In fact, as Captain Northrop went up onto the roof of Joint Security Station Sadr City on March 21 to gather his thoughts, six 107mm rockets passed overhead. Militiamen were overrunning checkpoints, but they had done that before, too. There were of course lulls in the fighting, which resembled the conclusion of previous incidences of violence. Only after fighting had intensified and persisted for several days did it become clear to U.S. commanders that they were in a major battle.<sup>17</sup>

On March 27, TF 1-68 CAB responded. Initially, Colonel Pappal wanted to concentrate his available forces on the situation in Shaab. Residents were calling the JSS, complaining of armed men in the streets. Pappal sent platoons to follow up on every report. Those platoons frequently made contact with enemy forces, defeating or driving them off. JAM forces in Husseiniya responded to Pappal's movement to Shaab by barricading themselves in the town. This ill-considered move allowed Pappal to isolate them with his B Company in an economy of force role.

Having learned that the Shurufi Mosque was the center of unrest in Shaab, Pappal organized a deliberate attack, partnering his units with Iraqi National Police, to clear

<sup>17</sup> Northrop interview.

the mosque and the surrounding neighborhood. U.S. units formed the outer cordon, while task force snipers provided overwatch as the Iraqis conducted the clearing operation. This action managed to clear Shaab of JAM, and subsequent U.S. patrols in the district encountered no enemy.<sup>18</sup>

Starting on the evening of that third day, the enemy attempted to renew its offensive, again focusing on Iraqi security forces. TF 1-68 CAB elements also encountered a couple of complex ambushes. This time, however, Iraqi forces by and large held their positions. By the end of the sixth day of fighting in both Baghdad and Basra, Moqtada al-Sadr called for a cease-fire, his stated reason being to end pointless bloodshed.<sup>19</sup> With the cease-fire, violence in Sadr City's outlying areas diminished considerably.

At the close of this initial phase, JAM had achieved a significant but incomplete victory over Iraqi security forces in Sadr City, but had been unable to dislodge U.S. forces. JAM had essentially cleared the Iraqi Army and police from Sadr City and its immediate perimeter. On the other hand, offensives in surrounding areas had basically fizzled: either defeated, as in Shaab, or contained, as in Husseiniya. JAM's tactical success had not translated into gains at either the operational or strategic level. Meanwhile, on March 25, Prime Minister al-Maliki launched "Operation Charge of the Knights"—the offensive on Basra—as planned and did not abandon it until Iraqi government forces were in firm control of that city.

## Seizing the Initiative: Operation Striker Denial

On March 25, al-Maliki ordered Iraqi and coalition forces to stop the rockets and restore government control in Sadr City. Everyone understood that most of the initial fighting would fall to the Americans. Al-Maliki's directive authorized U.S. strike operations throughout Sadr City and ground maneuver south of Al-Quds Street. Al-Quds Street, referred to as Route Gold (or PL Gold) in U.S. graphic control measures, remained the rigid limit of advance for U.S. ground forces throughout the operation.<sup>20</sup>

This restriction proved less troublesome than it might have; indeed, it was likely fortuitous. Neither 3-4 BCT nor MND-B had the forces to clear and hold Sadr City. At the beginning of the operations, Iraqi forces were incapable of doing either. As described in Chapter Three, Iraqi units were generally incapable of conducting mobile operations as units. Given political restrictions on the U.S. forces' ability to conduct operations by Route Gold, the Iraqis would have had to support and sustain them-

<sup>18</sup> Pappal interview. TF 1-68 AR, *Lion Firestorm*, pp. 4–5; Pappal, comments on draft.

<sup>19</sup> Sholnn Freeman and Sudarsan Raghavan, "Sadr Tells His Militia to Cease Hostilities; Cleric, in Return, Wants Followers' Release, Amnesty," *The Washington Post*, March 30, 2008, p. A1.

<sup>20</sup> Hort interview.

selves, something that contemporary observers concluded they were unable to do.<sup>21</sup> Route Gold, the U.S. limit of advance, actually stood near the extreme range of JAM's 107mm rockets, while the enemy had fewer of the longer-range 122mm rockets. In short, by controlling Ishbilyah and Habbibiyah, the neighborhoods south of Route Gold, U.S. forces could interdict most of the launch sites with ground forces, reducing the number of launch sites U.S. forces would have to control by strike operations to a manageable level.

Under the BCT's initial concept of operations, 1-2 SCR would control the launch sites while strike assets (e.g., Predator UASs, AH-64 Apaches) under BCT control interdicted enemy launch capabilities beyond Route Gold. MNC-I and MND-B had significantly augmented the reconnaissance and strike assets supporting 3-4 BCT for this purpose. Meanwhile, MND-B would focus on key leader attacks that were of strategic importance to the government of Iraq, MND-B, and MNC-I.<sup>22</sup> TF 1-68 CAB would continue to control the areas outside of Sadr City. After 1-2 SCR cleared the area south of Gold, Iraqi forces would advance to hold it. The scheme of maneuver for what was termed "Operation Striker Denial" is shown in Figure 4.5.

As events unfolded, it took considerably more combat power to seize and secure the rocket sites in Ishbilyah and Habbibiyah than a reduced-strength Stryker battalion. Before the fighting ended, TF 1-2 SCR, TF 1-68 CAB, and elements of Task Force 1-6 IN would be engaged in the effort to control Ishbilyah and Habbibiyah.<sup>23</sup>

### **Neutralizing Enemy Rocket Attacks with Aerial ISR and Strike Assets**

The effort to defeat the rocket teams from the air is the most discussed part of the Battle of Sadr City. We will therefore treat it first. As noted in the preceding section, this effort complemented ground maneuver in Ishbilyah and Habbibiyah to control launch sites there, an effort that eventually required most of 3-4 BCT's ground combat power. The BCT was able to concentrate its aerial surveillance and strike efforts on a relatively restricted area, the area beyond Route Gold that still lay within 107mm rocket range of the Green Zone.

To neutralize the rocket threat, MNC-I substantially augmented 3-4 BCT's aerial reconnaissance and strike capabilities. In total, the brigade received continuous support from two U.S. Air Force Predator UASs, at least one of which was armed; two Army Shadow UASs; six AH-64 Apache attack helicopters; Air Force fixed-wing CAS; and artillery, mainly GMLRS (guided multiple launch rocket system). In some respects, this augmentation was relatively modest. Essentially, 3-4 BCT received another bri-

<sup>21</sup> Cordesman, pp. 39–41; Jones, pp. 55–71.

<sup>22</sup> Colonel John Hort email to David E. Johnson, April 27, 2011.

<sup>23</sup> Hort interview; Rainey interview; Barnett, comments on draft. According to Barnett, TF 1-2 SCR quickly ceded C/1-68 AR back to TF 1-68, gaining operational control over B/1-14 Infantry and D/1-30 Infantry. D/4-64 AR later replaced D/1-30 IN.

**Figure 4.5**  
**Operation Striker Denial Scheme of Maneuver**

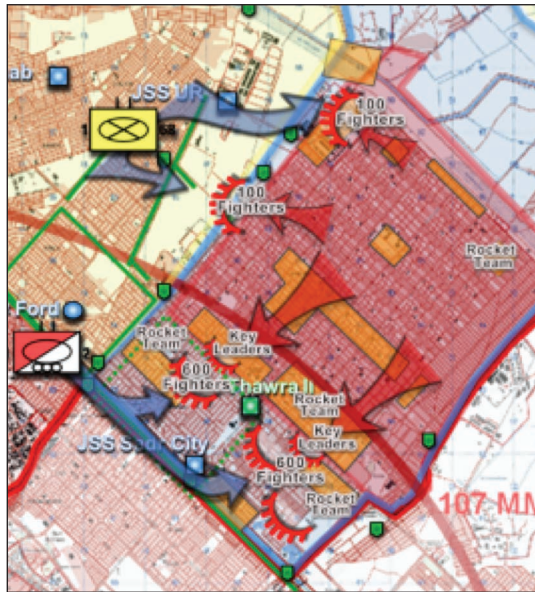

SOURCE: 3rd Brigade Combat Team, 4th Infantry Division, "Operation Iraqi Freedom, December 2007–March 2009."

NOTES: Orange-shaded areas are suspected or known point-of-origin sites of rocket launches. JSS = Joint Security Station.

RAND RR160-4.5

gade's worth of attack helicopter and Shadow support (Figure 4.6). Commanders typically weight the main effort by allocating resources in this fashion. What was truly unprecedented was letting the BCT control the Predator drones, which were essentially theater-level assets. In short, it was not the amount of support but the fact that they got it at all that was unprecedented. As we will describe later, even those relatively modest additional assets almost overwhelmed the BCT's ability to employ them effectively.

While brigade elements had exploited Predator imagery before, they had not yet employed the Predator in a strike role. 3-4 BCT's fight in Sadr City was MND-B's main effort and it allocated resources accordingly. To provide the continuous Shadow coverage required, MND-B had to strip another brigade of its Shadows. Likewise, the bulk of attack helicopters available to MND-B were given to 3-4 BCT. Thus, higher commanders took risk elsewhere to make sure 3-4 BCT had what it needed for the fight. These decisions obviously had consequences. 4-10 BCT, responsible for the area

**Figure 4.6**  
**MQ-1 Predator and RQ-7B Shadow**



SOURCE: U.S. Air Force website (left) and Todd Smith, Deputy Product Manager, Ground Maneuvers Product Office, U.S. Army (right).

RAND RR160-4.6

of operations adjacent to 3-4's to the east, did not have dedicated air weapons team support for the duration of the battle.<sup>24</sup>

Colonel Hort also received information from rapid aerostat initial deployment (RAID) sensors, counterfire radars, and other ISR assets.<sup>25</sup> His battle staff was able to integrate this information and communicate it to operational units down to the company level via a number of relatively new technologies. For example, they used persistent surveillance and dissemination system of systems (PSDS2) to integrate the various sensors. Figures 4.7–4.9 show, in order, an aerostat, a RAID tower, and PSDS2 monitor screens.

Additionally, Colonel Hort was able to communicate in a secure chat room–like environment via secure mIRC and to pass classified information via SIPR (SECRET Internet Protocol Router) down to the company level. All of these integrated sensors, communications systems, and strike assets gave 3-4 BCT the ability to find and kill JAM rocket teams and destroy other targets (e.g., mortars).

Developing effective tactics, techniques, and procedures for employing these assets took several days, however. Initially, the BCT delegated control of some deep strikes to its subordinate battalion task forces. Colonel Barnett, TF 1-2 SCR, remembered controlling several such strikes. Barnett, in turn, delegated control further to

<sup>24</sup> Hort interview; Ballagh interview.

<sup>25</sup> See Defense Industry Daily, “The USA’s RAID Program: Small Systems, Big Surveillance Time,” August 24, 2011. The article notes: “The RAID [rapid aerostat initial deployment] program is a combination of cameras and surveillance equipment positioned on high towers and aerostats, in order to monitor a wide area around important locations and bases.”

**Figure 4.7**  
**Aerostat**



SOURCE: Corporal Rich Barkemeyer, U.S. Army.  
RAND RR160-4.7

his company commanders. Captain Northrop, C/1-2 SCR, remembered using UASs and air weapons teams to monitor rocket points of origin in his sector during the first couple of days.<sup>26</sup> We draw attention to this circumstance to remind readers that materiel assets do not constitute capabilities in and of themselves, but require processes and doctrine to be effective.

It took about three or four days to work out the distribution of ISR and strike assets.<sup>27</sup> Part of the problem lay in the sudden shift in emphasis from stability operations to offensive operations. This problem was especially acute when engaging targets in the parts of Sadr City off limits to U.S. maneuver forces. Sadr City nominally fell within the maneuver commanders' areas of operations, making it their responsibility to clear fires. Normally, maneuver commanders do so based on either their own personal observation or the reports of someone they command. For the interior of Sadr City proper, that was not an option. At times, supporting air weapons teams would

<sup>26</sup> Jason Northrop, narrative comments, undated.

<sup>27</sup> Barnett, comments on draft.

**Figure 4.8**  
**RAID Tower**



SOURCE: U.S. Army photograph.

NOTE: This RAID tower is being installed in Afghanistan.

RAND RR160-4.8

**Figure 4.9**  
**PSDS2 Display Monitors**

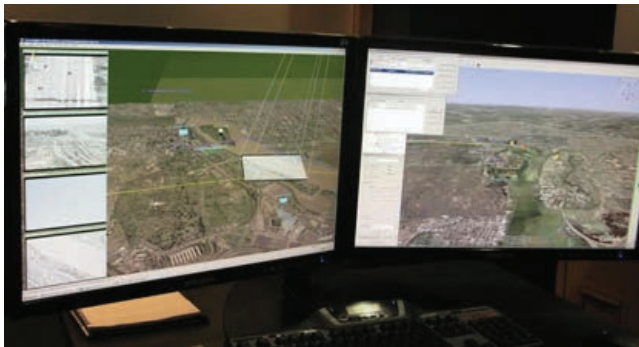

SOURCE: [http://defense-update.com/features/2008/november/231108\\_psd2\\_raid\\_sensors.html](http://defense-update.com/features/2008/november/231108_psd2_raid_sensors.html)

RAND RR160-4.9

report enemy activity. Ground commanders proved reluctant to authorize engagement based exclusively on pilots' reports, and would request verification through UAS feeds that they could observe. This caution may seem excessive in this context. Nevertheless, the reader should remember that U.S. air weapons teams had mistakenly shot a Reuters reporter and photographer in Sadr City in July 2007, a mere eight months before. While the video did not become public until July 2010, U.S. commanders were certainly aware of the potential consequences of an ill-informed decision. Often the window of opportunity would close while waiting on UAS availability, to the great frustration of Army aviation commanders.<sup>28</sup> We do not know whether the three to four days it took for 3-4 BCT to work out tactics, techniques, and procedures was an impressively brief or dangerously slow time span. We suspect it was just about right. In that sense, 3-4 BCT's experience provides an important datum about how long it might take for similar units to integrate analogous capabilities under combat conditions.

Respondents frequently told the research team that "the rules of engagement never changed" during the battle. That statement is literally true. Rules of engagement are essentially principles, however, such as "use minimum force consistent with self-defense." What such principles omit is who gets to decide what constitutes "minimum force," when U.S. forces are in danger, and who is posing a threat to them. Before the battle erupted, some battalion commanders reserved the authority to employ tank main guns, authorize Hellfire missile strikes, or employ close air support. After a few days of the battle, commanders usually delegated much of this authority to much lower levels. Colonel Pappal believed it necessary to remind his subordinates that vehicle commanders had all the authority they needed to use their main guns, a policy actually in effect before the battle. While the rule of engagement itself may not have changed, its interpretation and implementation during the battle certainly did, as constraints loosened. The guidance of General Petraeus to Colonel Hort perhaps best sums up this change. Colonel Hort recalls a conversation with General Petraeus early in the battle. Hort was somewhat reluctant to use Predator-launched Hellfire missiles early in the counter-rocket fight. According to Hort, General Petraeus counseled him: "They're predators—let them prey."<sup>29</sup>

Employing aerial ISR and strike assets strained the BCT's command and control (C2) capacity, not least because equipment often came without the skilled personnel necessary to manage it. According to Major Will Downing, who served as 3-4 BCT's "battle major" during the fighting in Sadr City, the operations section's air staff was manned and trained to handle requests for air support, not to manage continuous reconnaissance and strike operations. Eventually, the BCT received additional liaison officers from the 12th Aviation Brigade to help manage rotary-wing assets. The liaison officers talked to Apache pilots in the air to ensure that they were engaging the targets

---

<sup>28</sup> Because this is an extremely sensitive issue, we cite neither the source nor identify the individuals involved.

<sup>29</sup> Hort interview.



being observed in 3-4 BCT's TOC. The attached Air Force Tactical Air Control Party (TACP) also expanded 3-4 BCT's command and control capacity. Mostly, though, the staff simply had to reorganize to manage the additional reconnaissance and strike assets.<sup>30</sup>

The biggest issue was observation. Simply put, the BCT was getting more video feed from the additional Predators and Shadows than it had qualified people to watch. The UASs transmitted an immense amount of information, but someone had to watch a screen in order to make use of it. The BCT headquarters was not staffed to provide 24-hour monitoring of two Shadow feeds, and not staffed at all to monitor the Predator feeds. In the first few days of the operation, Colonel Hort would often find one of the screens uncovered, to his immense frustration. At one point, he made his brigade special troops battalion commander, a military intelligence officer, sit and watch the screen. Eventually, Hort retasked two warrant officers from other duties on the intelligence staff to watch the feeds.<sup>31</sup> The video feeds were providing important information, but that information was useless with no one to monitor and evaluate it in real time.

U.S. Air Force analysts in the United States also watched the Predator feeds. According to Downing, they provided invaluable support. Through experience and training, these analysts were able to interpret the sometimes ambiguous, grainy images to identify individuals carrying weapons, emplacing IEDs, and other hostile activities. Whenever 3-4 BCT's battle staff could not interpret footage from either the Predators or the Shadows, Downing would ask the airmen in the TACP for help. The airmen in the BCT's tactical operations center (TOC) would collaborate with other Air Force analysts stationed elsewhere to interpret the imagery in question.<sup>32</sup> Figure 4.10 depicts the wide array of assets employed by MNC-I used during the Battle of Sadr City.

Employing these assets quickly evolved into a drill. Counterfire radars would instantly identify a rocket launch and its point of origin. Operators at the BCT headquarters would then vector a UAS, usually a Shadow, to observe that point of origin. In general, the Shadows were considered more responsive than the Predators, though less capable overall. Operators preferred to acquire targets by reorienting the Shadow's sensors rather than changing the flight path, both to reduce the UAS's vulnerability and to avoid tipping the target off to the fact that they were under surveillance.

At first, rocket launch teams were attacked immediately after they had fired. However, the brigade battle staff soon developed "tactical patience," realizing that it was likely hitting only low-level operatives with vehicles and launch rails. Eventually, the staff adopted a practice of using an ISR platform to "watch the rail" and follow it. While the target was under observation, the staff organized assets to strike when appropriate,

---

<sup>30</sup> Major Will Downing, interview with M. Wade Markel and Brian Shannon, January 12, 2010; Hort interview.

<sup>31</sup> Hort interview; Downing interview; Lieutenant Colonel John DiGiambattista, former 3-4 BCT operations officer, interview with M. Wade Markel and Brian Shannon, Fort Carson, Colorado, January 12, 2010.

<sup>32</sup> Downing interview.

Figure 4.10  
ISR and Strike Assets Employed in the Battle of Sadr City

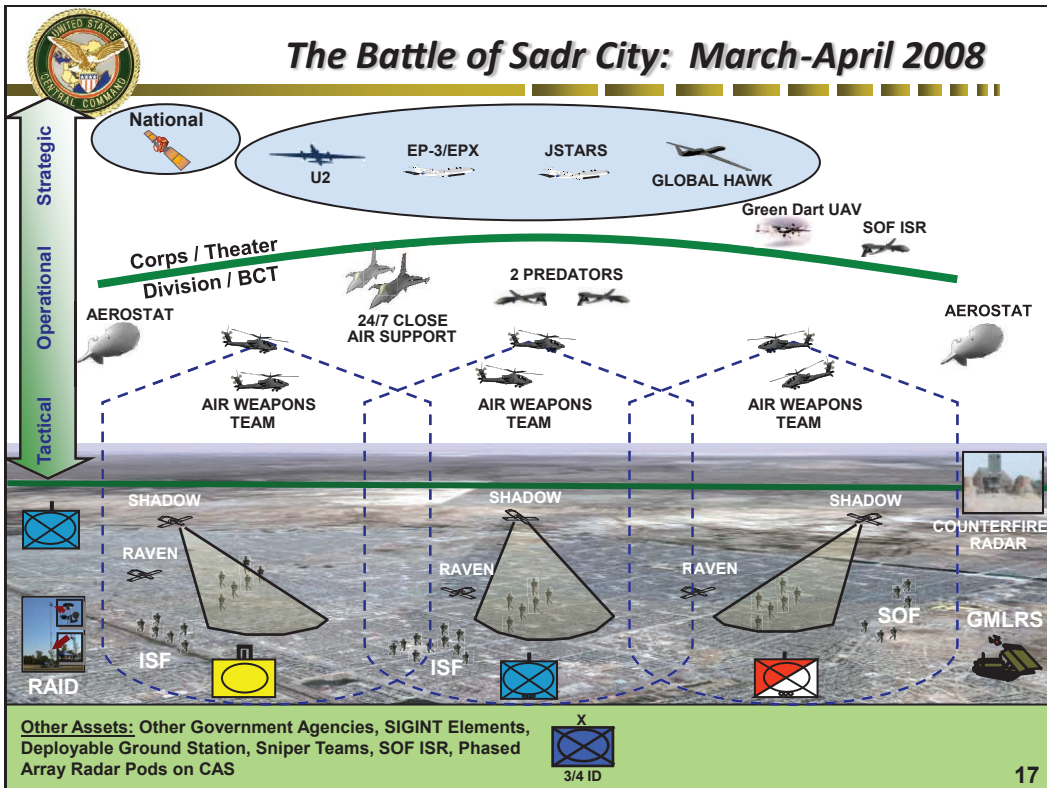

SOURCE: David H. Petraeus, "CENTCOM Update, Center for a New American Security," briefing, 2009.  
 NOTES: BCT = brigade combat team. CAS = close air support. GMLRS = Guided Multiple Launch Rocket System. ISF = Iraqi security forces. JSTARS = Joint Surveillance Target Attack Radar System. RAID = Rapid Aerostat Initial Deployment. SIGINT = Signals Intelligence. UAS = Unmanned Aerial System.

RAND RR160-4.10

either an armed Predator or attack helicopters. Once Hort, or later Downing, judged that there was nothing more to be gained from following the target, he would give the order to engage.<sup>33</sup> This was generally when the operatives returned to a supply point or a command location to get additional rockets and instructions, affording the opportunity to hit not only the lower-level operatives but higher elements of the network as well.

Figure 4.11 shows a series of five screen captures from Apache gun cameras during an actual engagement. In the first picture, militiamen have just pulled the tarpaulin from a rocket-launching rail. The truck in which the rail was transported is at the lower left-hand corner of the screen. In the next picture, the rocket launches and the rocket's exhaust flame is visible in the middle of the screen capture. In the third picture, mili-

<sup>33</sup> Hort interview; Downing interview.

**Figure 4.11**  
**Air Weapons Team Engagement of Enemy Rocket Crew**

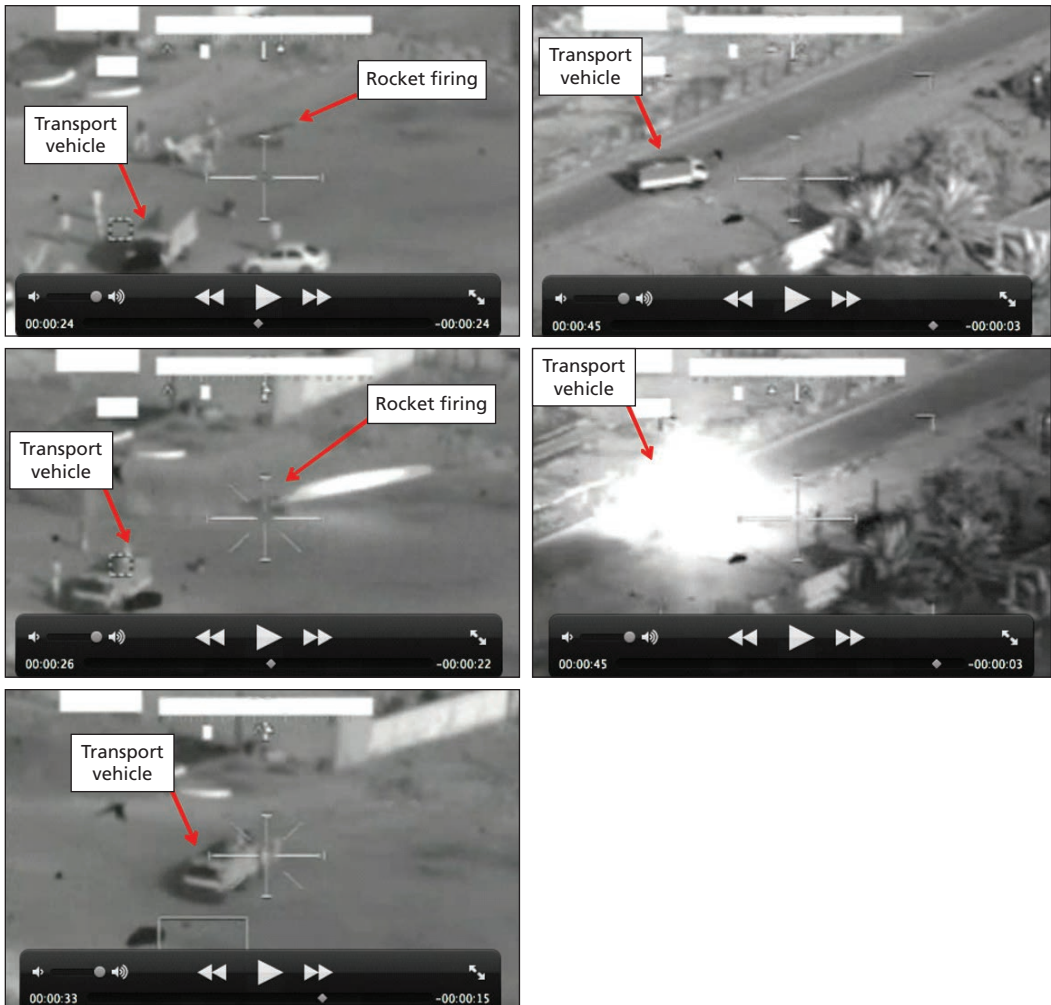

SOURCE: Task Force XII Public Affairs Officer, "GUN TAPE: MND-B Apache Pilots Engage Insurgents as They Launch Rocket Toward IZ," released March 31, 2008. The engagement took place at 4:20 in the afternoon, Baghdad time, on March 30, 2008.

RAND RR160-4.11

tiamen load the launch rail onto the back of the truck. The fourth shot shows that truck just before it is engaged, while the fifth picture displays the air weapons team destroying the truck, crew, and launch rail with a Hellfire missile.

Sometimes the decision to engage would be hours in coming; sometimes it would have to be made in seconds. The officer controlling the engagement constantly had to weigh the risk that civilians might be hurt or killed in the attack. In general, Colonel

Hort did not engage if there was a significant danger of injuring bystanders. Weighing all these criteria—the fleeting opportunity to strike, the possible intelligence value from further surveillance, and the need to minimize collateral damage—was critically important and demanded Hort’s attention during some of the fiercest parts of the ground fighting. It took over a week until Hort felt confident that his staff could weigh these factors correctly in his absence and know when and under what conditions to engage. During that time, six Stryker armored vehicles were destroyed or damaged in Ishbilyah and Habbibiyah.<sup>34</sup> Even though that level of combat intensity seemed to demand his attention, Hort felt the counter-rocket effort was even more important.

Within a month, strikes against the Green Zone emanating from beyond the area between Route Gold and the maximum range of the 107mm rocket largely ceased. According to Colonel Hort, the 3-4 BCT employed some 120 Hellfire missiles, six GMLRS, and eight Air Force guided bombs during the battle, a period lasting from March 23 through May 12, 2012.<sup>35</sup> He believes that these strike operations against the rockets destroyed five of seven 107mm rocket teams and degraded the capabilities of the 122mm rocket teams.

We do not know, however, precisely why the enemy stopped launching rockets against the Green Zone. The BCT may have killed most of them, but the staff never know how many such teams the enemy had in the first place. Major Brian Gibby, the brigade’s intelligence officer, noted that they were never really sure how many rocket teams the enemy had at the outset. Major Will Downing, the battle major, knew exactly how many rocket teams they killed during the course of the battle, but not how many remained. On the other hand, the success of the drone effort might have deterred the survivors. Certainly, the JAM Special Groups still had capability remaining that did not get used. Lieutenant Colonel Jim Rainey, the MND-B division operations officer, noted that Iraqi Army forces discovered substantial stockpiles of both 107mm and 122mm rockets when they occupied Sadr City north of Al-Quds Street, meaning the enemy still had rockets to fire. Taken together, this evidence indicates that the enemy may have retained significant residual capacity to launch rocket attacks. What is certain, however, is that they decided to stop trying to do so. What is also certain is that the BCT had become very good at acquiring, observing, tracking, and destroying rocket teams and their supporting infrastructure.<sup>36</sup> Aerial ISR and strike were necessary, indeed critical, to efforts to stop rocket attacks on the Green Zone, but they were

---

<sup>34</sup> Hort interview; Barnett, comments on draft.

<sup>35</sup> Hort email to David E. Johnson.

<sup>36</sup> Hort interview; Gibby interview; Rainey interview; Bryan Gibby, letter to M. Wade Markel, November 2, 2010. That said, there are still gaps in getting “ISR to the objective.” Colonel Farris noted that his platoon and lower levels of leaders still had to call back to higher echelons of command to find out what UAVs and other assets were finding on or near their objectives, because they did not have direct feeds. This was the case in 3-4 BCT as well.

not sufficient. Concurrent ground maneuver efforts to deny, seize, then secure rocket launch sites in Habbibiyah and Ishbilyah were required to achieve that end.

### The First Attempt to Control Launch Sites Through Active Patrolling

This aerial interdiction of rocket launches would not have worked nearly as well if JAM had had access to launch sites in Ishbilyah and Habbibiyah. Controlling those areas required hard fighting. The BCT's concept of operations evolved as the battle developed and they learned more about how JAM operated. Fundamentally, that concept centered around controlling launch sites in Habbibiyah and Ishbilyah with ground maneuver forces. Beyond Route Gold, where U.S. forces were not allowed to go, they would control launch sites using aerial ISR and strike to control the area beyond Route Gold but within 107mm rocket range, depicted as the cross-hatched area in Figure 4.12.

In retrospect, that concept evolved in three phases. Initially, 1-2 SCR was supposed to control the launch sites by active patrolling. Intense enemy resistance quickly forced 1-2 SCR to adopt a more deliberate approach. In the next effort, 3-4 BCT committed 1-2 SCR to seizing and holding the principal launch sites. It did not take long for U.S. commanders to realize that they required more combat power in Ishbilyah and Habbibiyah if they hoped to hold what they had taken. As the intensity of enemy resistance grew clearer, the BCT, MND-B, and even MNC-I had to channel more U.S. forces into the fight, requiring Hort and Hammond to accept risk in other portions of the brigade and division areas of operation. The intense combat also led Mike

**Figure 4.12**  
U.S. Concept of Operations

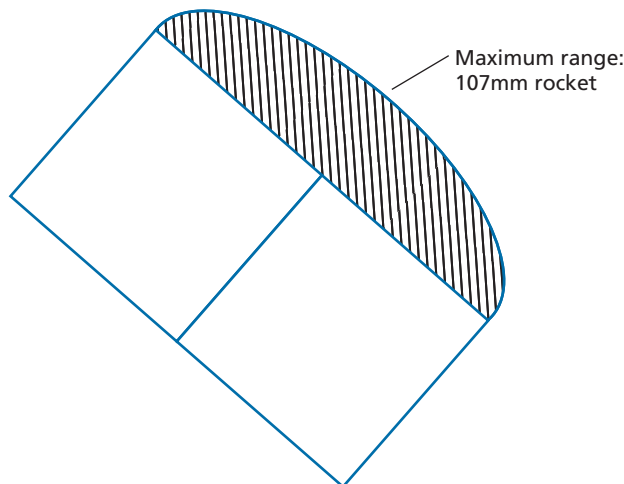

Pappal to make the transition from the up-armored HMMWVs, in which TF 1-68 CAB had been operating, to their Abrams tanks and Bradley Fighting Vehicles. Once U.S. units had seized the launch sites in Ishbilyah and Habbibiyah, the 3-4 BCT passed the 3rd Battalion, 42nd Iraqi Army Brigade through its units to secure Route Gold, the third phase of this part of the operation.

After stabilizing the situation, 1-2 SCR turned to the task of reestablishing control over Ishbilyah and Habbibiyah in order to deny JAM the ability to launch rockets from those areas. Initially, the squadron attempted to do so by employing mounted “disruption patrols”<sup>37</sup> on the major roads within Ishbilyah and Habbibiyah. According to Major Keller, 1-2 SCR’s executive officer, the closer those patrols got to Route Gold, the more intense the fighting became.<sup>38</sup> Whether these attacks formed part of a prepared defense was tough to tell, but JAM fighters were certainly much more aggressive in the area immediately to the south of Al-Quds Street. For the most part, the squadron did not allow Stryker vehicles to get any closer than a couple blocks south of Route Gold.

Platoons routinely found themselves surrounded by 50–100 fighters, and JAM employed IEDs in conjunction with their ambushes. In those ambushes the enemy employed every weapon at their disposal. Ambushes usually occurred near rocket launch sites, and Northrop believes they were intended to divert U.S. forces from those launch sites. When U.S. forces turned to fight through the ambush, the enemy would signal other JAM fighters with black flags. Shortly thereafter, enemy rocket teams would launch their rockets toward the Green Zone.<sup>39</sup>

The enemy also employed 120mm mortars against JSS Sadr City, a move that backfired when a stray round struck a nearby mosque. The mosque burned to the ground, something that a C Company platoon was able to capture on tape. That tape played a prominent role in influence operations; JAM did not employ that large a mortar again.<sup>40</sup> The mosque incident demonstrated that JAM had heavy weapons but could not always employ them effectively. The episode also demonstrated JAM’s relative incapacity with regard to information operations.

The experience of Northrop’s 2nd Platoon, led by then Lieutenant Kyle Morse, illustrates the nature and intensity of the opposition 1-2 SCR faced during the first few days. On the night of March 24, 2nd Platoon received word that Iraqi forces had been driven back to the intersection of Al-Quds Street and Bor Said Street; Northrop ordered them to reinforce those Iraqi forces and secure the checkpoint. When Morse arrived, he found about 200 Iraqi soldiers, two or three of whom were wounded, and

---

<sup>37</sup> We use the terms “active patrolling” and “disruption patrols” more or less interchangeably. Respondents used both terms to refer to the same activities.

<sup>38</sup> Keller interview.

<sup>39</sup> Northrop, written response to questions, August 14, 2010.

<sup>40</sup> Northrop, written response to questions, August 14, 2010.

about 50 vehicles. 2nd Platoon began escorting them back to JSS Sadr City. On the way back to their base, an EFP destroyed an attached Stryker from the reconnaissance platoon, and a big fight developed for control of the wrecked reconnaissance vehicle. 2nd Platoon was tasked to escort an M88 recovery vehicle and a HEMMTT (heavy expanded mobile tactical truck) wrecker to the crash site and recover the Stryker. They came under heavy enemy fire and engaged the enemy mostly using the remote weapons stations (RWS) on their Strykers. The 2nd Platoon sergeant recovered the damaged vehicle, dragging it out of the engagement area and then rigging it for recovery. When the platoon went out again on the third day, another EFP destroyed Lieutenant Morse's Stryker. Fortunately, though the materiel damage was extensive, the crew escaped with only minor injuries.<sup>41</sup>

The squadron's B Company encountered similar resistance. B Company's 3rd Platoon, led by Lieutenant Kenneth Elgort, was also conducting disruption patrols to deny JAM the ability to launch rockets. The platoon got caught in a complex IED ambush, followed up with small arms and RPG fire. An EFP struck the platoon sergeant's Stryker, disabling it. ISR reports from squadron headquarters indicated up to 50 militiamen maneuvering against 3rd Platoon, which remained under near-continuous attack for several hours. While the platoon killed many of the attacking militiamen with its organic weapons and was able to hold off the remainder, they were in danger of being overrun.<sup>42</sup>

The company commander, Captain Jon Bradford, dispatched another Stryker platoon to relieve 3rd Platoon. That platoon got caught up in a complex ambush as well. An EFP struck and disabled one of the two Abrams tanks sent to assist B Company in withdrawing. Return fire from the remaining tank's main gun and from the operational Strykers managed to suppress enemy direct-fire attacks. On the way out, however, 3rd Platoon struck six more IEDs.<sup>43</sup> Colonel Barnett believed the high number of IEDs showed that JAM had established at least hasty engagement areas to defend key launch sites, if not something more elaborate.<sup>44</sup>

The pattern of attacks indicated a well-coordinated plan to ambush the patrolling force and any relief force dispatched to its aid. That said, enemy execution did not match their plan's sophistication. The only casualties B Company suffered from that ambush were slight burns on the crew of the vehicle originally struck with the IED. Many of the EFPs and other IEDs they encountered were poorly constructed and not very effective.<sup>45</sup>

---

<sup>41</sup> Morse interview.

<sup>42</sup> Bradford interview.

<sup>43</sup> Bradford interview.

<sup>44</sup> Barnett, comments on draft.

<sup>45</sup> Bradford interview.

U.S. forces were winning the engagements, in the sense that they held the ground over which they had fought during each engagement and inflicted disproportionate casualties on attacking militiamen.

This heavy fighting was taking its toll on enemy fighters, as well as 1-2 SCR's vehicles, but it was not succeeding in denying the enemy the ability to launch rockets at the Green Zone. In Colonel Hort's view, the Stryker armored vehicles lacked lethality and survivability compared with available tank and mechanized forces.<sup>46</sup> The Strykers were not necessarily uniquely vulnerable, as the charred remains of a Bradley Fighting Vehicle depicted earlier in Figure 2.2 makes clear. More importantly, as illustrated by the subsequent experience of armored company teams attempting to "commute" to the later fighting around the Gold Wall, it may be that no combat vehicle in the U.S. inventory would have had the protection to control the launch sites by running a daily gauntlet of EFPs through the warren of Ishbilyah and Habbibiyah streets and alleyways. Still, the Strykers could not equal M1 tanks' 70 tons of armor and firepower. Most importantly, 1-2 SCR simply lacked the manpower to control these two areas by itself.

### **Augmented U.S. Forces Seize Launch Sites South of Route Gold**

3-4 BCT reoriented, concentrating 1-2 SCR on Ishbilyah and sending TF 1-68 CAB into Ur and Habbibiyah. To enable TF 1-68 CAB to increase the area of operations for which it was responsible, Colonel Hort augmented the task force with Team C, 1st Battalion, 64th Armored Regiment; A Company, 1st Battalion, 21st Infantry Regiment (Stryker); and C Company, 1st Battalion, 27th Infantry Regiment, all provided to Hort by MND-B.<sup>47</sup> By now, all armored and mechanized units were operating in tanks like those depicted in Figure 4.13.

At this point in the battle Moqtada al-Sadr issued a call for JAM to cease fighting and cooperate with government security efforts. Intelligence analyses, however, warned U.S. units to expect continued combat by JAM elements who disapproved of the cease-fire.<sup>48</sup> From the subsequent fighting's intensity, it is not clear whether al-Sadr issued his proclamation for effect or for show. Fighting in Shaab and other outlying areas did, however, decline dramatically. Al-Sadr's cease-fire may have reflected an assessment that the uprising had failed to achieve its strategic objectives and that it was time to cut his losses.

If so, continued fighting indicates that his interests and those of his nominal subordinates in Sadr City had begun to diverge. Local commanders told Western reporters that the cease-fire placed them in a bind. A low-level JAM commander told Reuters that

---

<sup>46</sup> Hort interview.

<sup>47</sup> Keller interview; TF 1-68 AR, *Lion Firestorm*, p. 8. Pappal, comments on draft.

<sup>48</sup> TF 1-68 AR, *Lion Firestorm*, p. 7.



**Figure 4.13**  
**Abrams Tanks During the Battle of Sadr City**



SOURCE: Provided to the authors by the 4th Infantry Division.

RAND RR160-4.13

We don't know what to do. If we carry guns the government will oppose us, but if we put them down, the Americans will come, surround our homes and capture us.<sup>49</sup>

Another local commander echoed this concern. While al-Sadr may have viewed a cease-fire as essential to his political survival, local commanders thought that continued fighting was essential to their personal survival.

At this point, when efforts to deny launch sites to JAM through disruption patrols had largely failed, 3-4 BCT decided to suppress rocket launches by seizing the principal launch sites and establishing overwatch.<sup>50</sup> Once again, the mission initially fell to 1-2 SCR. By this time, however, 3-4 BCT had relieved them of responsibility for other parts of the area of operations. 3-4 BCT originally scheduled the attacks for 0800 on March 29, 2008. General Grimsley, MND-B's deputy commander for maneuver, delayed the attack because he was concerned about 1-2 SCR's ability to make the

<sup>49</sup> Wisam Mohammed and Ahmed Rasheed, "Truce Call Catches Militants Off Guard; Iraqi Shiite Cleric Urges Fighters to Stop Battling Government Forces," *The Toronto Star*, March 31, 2008, p. AA01.

<sup>50</sup> Hort interview; Keller interview.

wrenching transition from stability operations to offensive operations.<sup>51</sup> By mid-day, however, the squadron had managed to make the necessary adjustments and initiate the assault. Once again, U.S. forces encountered determined, if unskillful, resistance. By day's end, however, they had seized the rocket sites assigned to them and were holding them. This result substantially curtailed the enemy's ability to launch rockets at the Green Zone.

B/1-2 SCR's fight to seize named area of interest (NAI) 608 is illustrative of the larger battle. NAI 608 was an open soccer field and probable rocket-launching site located next to a school, bordered on one side by a large market and on another by a large apartment building. The scheme of maneuver involved D/1-30 IN, a mechanized infantry company attached for this operation, making a feint to distract JAM while B/1-2 SCR attacked to seize NAI 608 using an indirect approach. D/1-30 IN's feint seemed to spare B Company heavy contact, but they still encountered several IEDs and sporadic enemy small arms fire. Their final approach to the objective involved using attached tanks to breach the wall surrounding the soccer field.

Once through the wall, B Company moved to seize a three-story apartment building overlooking the soccer field. Unfortunately, all the building's doors opened to the outside, making it more difficult to kick them in and break into the building. Once B Company soldiers started clearing the building, they started receiving enemy fire from three sides. Given the relative surprise that B Company had achieved in arriving at the objective, the enemy's ability to concentrate fire on the apartment building indicates a certain degree of preparation. Bradford then directed his men to abandon their exposed positions in the apartment building and seize the nearby school. At one point, between 75 and 100 JAM militiamen tried to mass to assault B Company's position, but B Company was able break up their attack.<sup>52</sup>

From then on, it was simply a matter of holding onto their position. Enemy fighters would gather beyond line of sight in groups of four or five men, then move to a position from which they could engage Bradford's soldiers. Such attacks were a deadly nuisance, but they did not threaten B Company's hold on the objective. These small groups did not attempt to maneuver, and at no point did JAM fighters attempt to mount a coordinated attack to retake their positions. By March 30, 1-2 SCR had mostly "locked down" the area.<sup>53</sup>

As the fighting went on, the BSB found itself under increasing pressure to provide manpower for operating base security and other taskings. Colonel Hatcher resisted these efforts, thinking that they risked fracturing critically needed sustainment capa-

---

<sup>51</sup> Major General William F. Grimsley, video teleconference with David E. Johnson, M. Wade Markel, and Brian Shannon, May 26, 2010; Keller interview; Bradford interview.

<sup>52</sup> Bradford interview.

<sup>53</sup> Bradford interview; Keller interview; Morse interview. In his interview, Mike Pappal reported that by the time they deployed to Habbibiyah, 1-2 SCR had mostly taken care of the hard fighting.

bility. Hatcher responded by educating maneuver commanders on what his soldiers were doing and could do to support operations.<sup>54</sup> The very fact that such pressure existed, however, testifies to the intensity of the fighting.

### **The Iraqi Army Attacks to Secure Route Gold**

U.S. forces had seized the launch sites, ending the immediate threat of 107mm rocket attacks from Habbibiyah and Ishbilyah. The BCT was successfully countering enemy attacks north of Route Gold using aerial strike and ISR. Neither Colonel Hort nor General Hammond could afford to leave 1-2 SCR and TF 1-68 tied down in these static positions indefinitely, however. The plan was for the 3rd Battalion, 42nd Iraqi Army Brigade to attack to secure Route Gold. Having achieved this objective, it was thought that it could control infiltration and thereby deny the launch sites to the enemy. Their efforts to do so illustrate the state of Iraqi capabilities at the beginning of the battle and how they evolved in combat. According to General Hammond, Colonel Hort, and other observers, the resulting improvements in Iraqi leadership, capabilities, and especially confidence resulting from their participation in this attack contributed substantially to their ability to operate independently thereafter.

Once 1-2 SCR had successfully seized the rocket launch sites, it was time for the Iraqi Army to secure them. On April 5, 2008, the 44th Iraqi Army Brigade was supposed to attack through 1-2 SCR in order to seize Route Gold. The 3rd Battalion, 42nd Iraqi Army Brigade, commanded by Lieutenant Colonel Y, was the brigade main effort. Though the battalion fell under the command of the 44th Iraqi Army Brigade for this mission, Brigadier General X, the 42nd Brigade's commander, kept a close eye on his subordinate unit during the mission. Iraqi planning for the operations was haphazard and incomplete, execution was confused, and units often panicked.<sup>55</sup> The Iraqis provided maneuver forces, but attacked in up-armored HMMWVs because they were generally unready for combined arms mechanized operations. They lacked critical enablers, including fires, reconnaissance, and logistics. Most critically, they lacked route clearance packages, engineer elements specializing in clearing IEDs.<sup>56</sup>

The mission was more important in the strategic sense than it was in the immediate tactical sense. 3-4 BCT was more than capable of controlling Ishbilyah and Habbibiyah for the moment and was demonstrating the ability to deny launch sites in the rest of Sadr City to JAM rocket teams from the air. But time on U.S. forces' remit within Baghdad was expiring rapidly. The impending implementation of the Status of Forces Agreement would require the withdrawal of U.S. forces, at which time the

---

<sup>54</sup> Hatcher email, 2011.

<sup>55</sup> Their conduct was similar to that of many American units committed to combat for the first time in Normandy after the D-Day invasion. See, for example, John Colby, *War from the Ground Up: The 90th Division in WWII*, Austin, Tex.: Nortex Press, 1991.

<sup>56</sup> Hort interview; Hammond interview; North interview; Collings interview.

Iraqis would have to be able to secure their own territory. If the government of Iraq was going to be able to secure Baghdad in the future, its Army had to be able to fight in Sadr City now.<sup>57</sup>

An attack against prepared opposition represented an unprecedented challenge for these units. As already mentioned, the Iraqi Army in Baghdad had been mostly a “checkpoint army” to this point. Now they would have to advance against an opponent that had been giving U.S. forces a tough fight. Iraqi commanders often lacked confidence in themselves and their units. Captain Bradford remembers that his Iraqi counterpart asked for U.S. armored vehicles to lead his attack. Bradford could not oblige, because he was under orders to let the Iraqi Army fight on its own. Iraqi commanders’ tentativeness was also revealed in their decision to attack along the main roads, instead of along the narrow alleyways between them.<sup>58</sup> For trained troops, the latter approach would have reduced their exposure to IEDs and possibly evaded some enemy defenses. Given the state of the Iraqi Army’s preparation, there was always the risk of losing control of the situation if one of the attacking Iraqi elements ran into difficulty and bolted.

While Iraqi maneuver forces were supposed to provide the bulk of the combat power used for this offensive, U.S. engineers were still to lead the attack, clearing routes along the major thoroughfares along which Iraqi forces would attack. Shortly before the attack, however, orders went out for the engineers to wait in reserve, moving forward only when the Iraqis encountered obstacles that they could not surmount. We can only speculate, but presumably coalition commanders wanted this to be an Iraqi operation in more than name only.

Shortly before night fell, the Iraqis advanced. It did not take long for them to encounter such obstacles. Within a few minutes, lead elements encountered IEDs, probably EFPs. Orders went out for U.S. engineers to clear routes in advance of the Iraqis. Now U.S. route clearance assets had to clear a path for Iraqi vehicles to advance.<sup>59</sup>

Sergeant Corey Collings recalls that his unit encountered exceptionally thick belts of obstacles. The engineers’ standard operating procedure was to continue clearing operations in zone until the two Husky vehicles accompanying a patrol were disabled. Patrols led with the Huskies because they only had one crewmember, the driver. In the event a mine was to catastrophically destroy the lead vehicle, a platoon would lose only one man instead of the whole team manning an RG-31. Fortunately for the 237th Engineer Company, whose normal mission was to support 3-4 BCT, they suffered no such losses that night or through the rest of the battle of Sadr City. Most damage was similar to that depicted in Figure 4.14. Maintenance crews would quickly repair the damage, and the Husky would be out on the road again the next day.

---

<sup>57</sup> Hammond interview; North interview.

<sup>58</sup> Hammond interview; Bradford interview; Pemrick interview.

<sup>59</sup> Collings interview.

**Figure 4.14**  
**Battle-Damaged Husky Vehicle Mounted Mine Detection (VMMD) System**



SOURCE: Sergeant Corey Collings.

RAND RR160-4.14

That night, one platoon was only able to clear two streets and a portion of a third before losing both its Huskies. In that short span of time, the platoon detonated thirteen IEDs. In the days to come, the engineers would repeat this experience. Corey Collings's platoon cleared the same set of routes twelve times over the next several days.<sup>60</sup>

The rest of the attack was touch and go. Some small units, particularly those led by recent graduates of the Iraqi military academy, acquitted themselves well and quickly attained their objectives. Major Brian North, the advisor to the 42nd Brigade, remembers one particularly effective Iraqi platoon leader seizing Jamiliyah Square, the traffic circle at the intersection of Al-Quds Street and Thawra Street that was the principal terrain feature on Route Gold.

Iraqi companies came under increasingly heavy attack as they advanced and halted a few hundred meters short of Al-Quds Street. There they established battle positions from which they would dispatch patrols to observe and control Route Gold.<sup>61</sup> These positions fell somewhat short of Route Gold, their nominal objective. At the time, some U.S. leaders viewed this as evidence that the Iraqis had once again fallen

<sup>60</sup> Collings interview.

<sup>61</sup> North interview; Pemrick interview.

short of expectations. On the other hand, the taller buildings north of Al-Quds Street tended to dominate those to the south. Thus, the Iraqi commanders' choice of positions likely combined a reasonable appreciation of the terrain with the inability to coax any more out of their anxious soldiers.<sup>62</sup> Once in these positions, small groups of JAM militiamen subjected the Iraqi soldiers to constant harassing attacks by fire.

The operation had threatened to stall before the Iraqi companies established their battle positions. The Iraqi Army units committed to the battle had encountered substantial obstacles and taken significant casualties. For the Iraqi Army this was the decisive point. If they broke under pressure and failed to take and hold their positions, they might once again have conceded moral ascendancy to JAM, something that they would never regain. Confronting serious resistance, overwhelmed by the stress and confusion of battle, Iraqi commanders were inclined to withdraw. General Hammond remembers standing on the ground at the battle's leading edge, heatedly remonstrating with General M, the 44th Brigade Commander, and the 9th Division commander on the vital importance of holding their ground. He was growing increasingly frustrated. Major Mark Rosenberg, Y's advisor, interrupted General Hammond, saying: "Sir, I've got it." Taken aback at Rosenberg's temerity, Hammond turned his attention to him. Rosenberg convinced Hammond that he understood the gravity of the situation and would accomplish the mission.<sup>63</sup>

General Hammond characterizes this as the point in the battle in which everything hung in the balance. Somehow, Rosenberg managed to inspire his counterpart, Lieutenant Colonel Y. Between the two of them, they coaxed and cajoled remaining Iraqi soldiers up to their company battle positions, where they consolidated. According to Hammond, Iraqi commanders subsequently attributed the Iraqi Army's success in attaining and holding its positions to the great command team of Colonel Y and Major Rosenberg.<sup>64</sup>

Rosenberg and Y had a lot of help. Major Downing, in the 3-4 BCT TOC, remembers watching Colonel Pemrick on a UAS feed during the battle. Pemrick would walk up in front of Iraqi armored vehicles leading the attack and knock on their hatches in order to cajole the Iraqis to go forward. General Grimsley was also omnipresent throughout the battle area. Sadly, after having helped retrieve the situation, Major Mark Rosenberg was killed when an EFP struck his vehicle as he returned to his forward operating base.

It wasn't just Americans coaxing the Iraqis forward and holding them there. Brigadier General X of the Iraqi Army's 42nd Brigade also took an increasing role in the battle when his 2nd Battalion was committed to the fight in Ishbiliyah and Habbibiyah. Though the conduct of the battle was at least nominally the responsibility of the

---

<sup>62</sup> Hammond interview; Downing interview; Pemrick interview; North interview.

<sup>63</sup> Hammond interview.

<sup>64</sup> Hammond interview.

44th Brigade's commander, the two units fighting it belonged to Brigadier General X, who was sure to be blamed if things went wrong. He started making sure that things did not go wrong. At one point, Brigadier General X stopped a supporting Iraqi tank company from withdrawing by standing directly in its path.<sup>65</sup>

As it was, the Iraqis suffered from their inexperience and indiscipline. Many would expose themselves unnecessarily to enemy fire. They would stand up to light a cigarette, or simply take a look at what was going on outside their position. Worse, they would do so without their helmet and body armor. The Iraqis suffered several unnecessary casualties as a result. The relative immobility of Iraqi units in their company battle positions and those units' relative passivity with regard to patrolling allowed JAM elements to assemble unmolested and attack them by fire almost at will. The volume of such attacks convinced U.S. and Iraqi commanders that they needed to reinforce Y's battalion with Brigadier General X's 2nd Battalion, 42nd Brigade.<sup>66</sup>

Like many green troops, the Iraqis mistook these piecemeal attacks for something much more serious. The commander of the 2nd Battalion, 42nd Brigade was preparing to withdraw under the pressure of one of these minor attacks until Major North was able to show him a Shadow feed that starkly illustrated that what seemed like a large-scale attack on his position was only a few militiamen firing haphazardly. The Iraqi colonel held, that time, though he later had to be relieved.<sup>67</sup>

At the end of the operation, the Iraqis had conducted a successful battalion attack. As noted earlier, few Iraqi units were capable of operating in that manner. Moreover, they had done so against JAM, a force that had thoroughly cowed the previous Iraqi Army units operating in Sadr City. They had made many mistakes and taken unnecessary casualties. The Iraqis had needed considerable help and encouragement from their U.S. advisors, and several Iraqi officers had been found inadequate. For all that, they had fought and won. As General Hammond later noted, what was more important was that they believed they had won, and could win again. This would prove especially important when the 44th Brigade had to advance beyond Route Gold and establish Iraqi control over the rest of Sadr City, unaided by U.S. forces.

## Summary and Conclusions

For all that, the situation remained untenable. Both Iraqi and U.S. forces remained exposed to continuous attack from the part of Sadr City beyond Al-Quds Street. Policy and lack of capacity continued to render that area an effective sanctuary for JAM. Colonel DiGiambattista, 3-4 BCT's operations officer, remembers watching UAS feeds of

---

<sup>65</sup> North interview; Brigadier General X later relieved that battalion commander.

<sup>66</sup> North interview; Bradford interview.

<sup>67</sup> North interview.

groups of military-age males casually assembling deep in Sadr City. They would throw their weapons into the trunks of cars, then drive along Sadr City's major thoroughfares to points just north of Al-Quds Street. There they would get out of their cars, retrieve their weapons, and go attack Iraqi Army positions. After the engagement, they would get back in their cars and drive away. In short, the current situation left U.S. and Iraqi forces exposed to continuous attack at times and places of the enemy's choosing. While the UASs' multiple sensors could observe this activity, available aerial strike assets were completely dedicated to the rocket fight. If the Iraqis were to hold Ishbilyah and Habbibiyah, something had to be done to limit enemy attacks.<sup>68</sup>

At the end of the battle's initial phase, coalition forces held Route Gold and the launch sites in Ishbilyah and Habbibiyah, and were suppressing enemy rocket attacks from the area beyond Route Gold using aerial strike and ISR. Securing the launch sites in Ishbilyah and Habbibiyah eventually required 3-4 BCT to commit all of its maneuver forces, including additional forces provided by MND-B, to those two districts. U.S. commanders had had to augment not only the capacity committed to Sadr City but also U.S. capabilities. U.S. units traded in their up-armored HMMWVs for tanks and Bradley Fighting Vehicles. Their hold was tenuous, however, under continuous JAM attack. The Iraqis' grasp on their positions was especially tenuous. On the U.S. side, neither Colonel Hort nor General Hammond wanted to leave substantial U.S. forces securing rocket sites for the remainder of their tour in Baghdad. Coalition forces had to do something to change the dynamic.

---

<sup>68</sup> DiGiambattista interview.





## Defeating JAM: Operation Gold Wall

---

U.S. commanders decided to control JAM infiltration using the same tactic that had contained the Sunni insurgency: building walls. They decided to build a wall along Route Gold because it was the major terrain feature nearest the outer range from which 107mm rockets could strike the Green Zone. It was also the furthest limit of advance for U.S. forces, as the al-Maliki government never relented on its ban of U.S. forces north of Route Gold. The wall succeeded in limiting infiltration, but it also drew JAM elements remaining in Sadr City into a decisive battle. Their motivation for accepting combat on such disadvantageous terms is not clear, but it seems as if the wall threatened local JAM leaders access to the Jamiliyah Market, from which much of their revenue was derived. Perhaps JAM leaders also foresaw that the wall threatened to trap them in Sadr City as raids picked them off one by one. For whatever reason, JAM fought hard to stop the wall, losing hundreds if not thousands of fighters in the process.

### The Decision to Build a Wall

The warren of alleyways and many small buildings in Sadr City, Ishbilyah, and Habbibiyah provided routes for JAM fighters to infiltrate the area below Route Gold. Thus, to hold what they had taken, U.S. and Iraqi forces had to deny JAM its ability to attack at will south of Route Gold. Quite simply, there were too few coalition forces to secure Route Gold against an enemy that could prepare at leisure and pick their point of entry or attack. Brigade and division level leaders understood that something had to be done to limit JAM's access to Ishbilyah and Habbibiyah, and that the Iraqi Army would not be able to do this with checkpoints alone.

To stop JAM from moving at will, 3-4 BCT began building a wall along Route Gold. It is not clear where the idea for a wall originated in this instance, but there were plenty of precedents from earlier U.S. operations in Iraq, most recently from 2-82 BCT's tour.<sup>1</sup> Certainly the wall along Route Gold followed the pattern established by

---

<sup>1</sup> Most of those with whom we spoke credited either Colonel Hort or Colonel Farris. Hort himself credits Farris, as does Barnett.

Colonel Farris and 2-82 BCT. Access to the area below Route Gold was vital to JAM, so it became key terrain for Colonel Hort. To stop the wall, JAM came into the open, waging an unequal battle against U.S. soldiers, tanks, and fighting vehicles. While U.S. commanders welcomed this reaction, it was a side effect. The wall's originally intended purpose was to limit JAM's access to the rocket launch sites in Ishbiliyah and Habbibiyah. Operation Gold Wall commenced on April 15, 2008, and is depicted in Figure 5.1.<sup>2</sup>

Initially, the plan was for U.S. forces to work at night, exploiting their vastly superior night-fighting capabilities. 1-2 SCR was to work from Sadr City's eastern edge to Jamiliyah Square in the middle, while TF 1-68 CAB would build the wall from the middle to the northwest. What 3-4 BCT soon discovered, however, was that the pause during daylight hours gave the enemy time to reseed IEDs, while separating the two efforts doubled the routes that required clearance to get to the wall construction sites. Each night, both task forces would have to conduct separate deliberate breaching operations to return to the point at which they had stopped work the previous night. Early in the operation, C/1-68 CAB, TF 1-68 CAB's main effort, encountered seven EFPs

**Figure 5.1**  
**Operation Gold Wall**

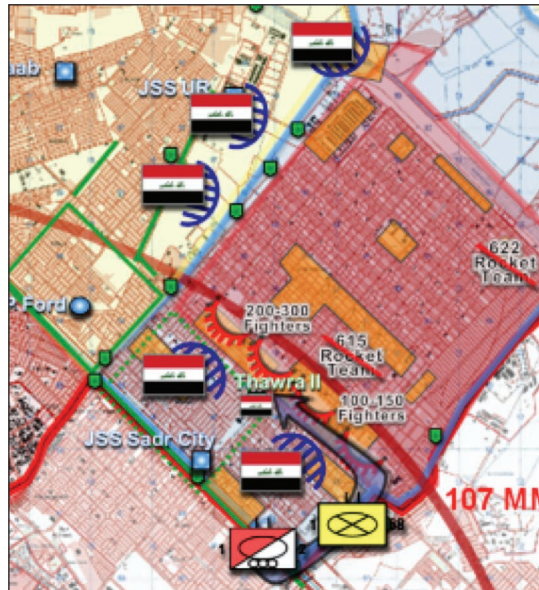

SOURCE: 3rd Brigade, 4th Infantry Division, "Operation Iraqi Freedom December 2007–March 2009."

RAND RR160-5.1

<sup>2</sup> Headquarters, 3-4 BCT, "Lessons Learned"; Rainey interview; Hort interview; DiGiambattista interview.

in two minutes near the ruins of the Jamiliyah Market. Sometimes the route clearance effort would take all night, leaving no time for actual wall construction. After several days of such futility, the BCT reorganized the effort as a continuous, 24-hour-a-day operation, building the wall from the eastern edge. While this accepted greater exposure during daylight and surrendered the U.S. night-vision dominance, it denied the enemy the time to reseed obstacles unmolested and allowed U.S. forces to secure their lines of communication more effectively.<sup>3</sup>

U.S. forces also modified their procedures for coping with IEDs and EFPs for this fight. Prior to the uprising, route clearance teams had carefully attempted to disarm each IED or EFP with the intent of using the resultant intelligence to help them target insurgents. Clearing a mine in this fashion took several hours, however, time that U.S. forces no longer cared to take when the enemy was presenting itself so openly. Instead, they would shoot suspected IED locations with either .50 caliber machine guns, 25mm chain guns, or canister from 120mm tank main guns. Such engagements made short work of the device or its command detonation features.<sup>4</sup>

Colonel Pappal organized his portion of the wall-building effort as a deliberate breaching operation. TF 1-68 CAB's engineer company conducted a route clearance effort at the leading edge of the wall.

Figure 5.2 illustrates the necessity of this methodical approach. On one particular occasion, U.S. M1s got out ahead of their route clearance teams. The tank in question was sitting directly opposite the EFP being interrogated by the robot. The EFP itself, a matte black object shaped like a coffee can, was almost indistinguishable from the pile of refuse in which it sat. Fortunately, a member of the route clearance patrol spotted the mine and warned the tank crew before the enemy attempted to detonate the IED.<sup>5</sup>

Captain Looney's C Company was the core of the effort, providing security with its tanks and Bradley Fighting Vehicles. The brigade's support battalion provided a continuous stream of concrete T-wall sections to build the wall along a route secured by TF 1-68 CAB's D Company. A civilian crane operator emplaced the walls, as shown in Figure 5.3.

Once a section of the wall was set, a soldier had to climb up on a ladder and unhook the crane cable, as shown in Figure 5.4, exposing himself to JAM fire.

During its shift on the wall, 1-2 SCR organized its efforts in a similar fashion, employing an attached armor company, D Company, 4th Battalion, 64th Armor (D/4-64 AR).<sup>6</sup> Brigade headquarters supported the effort with UASs and attack helicopters,

---

<sup>3</sup> Pappal interview; Looney interview.

<sup>4</sup> Hort interview; Pappal interview; Barnett, comments on draft.

<sup>5</sup> Collings interview.

<sup>6</sup> Pappal interview; Looney interview; Keller interview.

**Figure 5.2**  
**M1 Tank and EFP on Route Gold**



SOURCE: Sergeant Corey Collings.

RAND RR160-5.2

which were essential to identifying and disrupting JAM attacks from north of Route Gold.<sup>7</sup>

While the wall's intended effect was simply to deny rocket teams access to Ishbiliyah and Habbibiyah, its effect was to draw the enemy into intense combat on extremely disadvantageous terms. Colonel DiGiambattista and Colonel Gibby anticipated this outcome. They knew that JAM commanders derived much of their income from the Jamilyyah Market and would fight to retain access. More importantly, the wall also denied access to Ishbiliyah and Habbibiyah's population, and with it, JAM's ability to intimidate and coerce them.<sup>8</sup> Building the wall transformed the battle from the Sadrist Trend's bid for national power to a local fight for power and survival by local JAM commanders. For JAM commanders, if the wall were to be finished, they would be, too. Thus, the wall "agitated" the enemy and forced it to attack U.S. forces that had enormous tactical advantages.<sup>9</sup>

The wall proceeded inexorably, though 3-4 BCT achieved greater progress on some days than on others. It was particularly troublesome when an enemy sniper shot

<sup>7</sup> Downing interview.

<sup>8</sup> Gibby interview; DiGiambattista interview.

<sup>9</sup> Hort interview.

**Figure 5.3**  
**Emplacing a T-Wall Section**



SOURCE: Provided to the authors by the  
 4th Infantry Division.  
 NOTE: Notice the Bradley IFV in the background  
 providing overwatch.

RAND RR160-5.3

the crane cable with a Steyr .50 caliber sniper rifle; replacing the cable could take all day. In response to this threat, 3-4 BCT employed its organic snipers and those of a SEAL team in an evolving countersniper fight. Had U.S. forces been unable to suppress JAM snipers, the latter could have delayed progress indefinitely simply by shooting the crane cable every so often. Had they been able to do so, JAM might have outlasted the al-Maliki government's persistence. As it was, by suppressing enemy snipers, even if only partially, U.S. snipers enabled the wall to proceed at a reasonable pace.

JAM resistance was fierce, but ultimately futile. Brigade units fired over 800 120mm tank main gun rounds and over 12,000 25mm rounds from Bradley Fighting Vehicles (Figure 5.5). They also used CAS with precision-guided bombs to destroy buildings that had snipers in them when other brigade weapons could not silence them.<sup>10</sup>

<sup>10</sup> Northrop interview.

**Figure 5.4**  
**Unhooking a T-Wall Section**



SOURCE: Provided to the authors by the 4th Infantry Division.

RAND RR160-5.4

The enemy's ability to coordinate attacks dwindled as the wall extended. At first, the enemy was able to attack in up to platoon strength. Just before resistance ceased, JAM could only manage four- to five-man elements. U.S. officers have been extremely reluctant to speculate about the number of casualties they inflicted, but one company alone counted over 200 enemy killed in its engagements. Figure 5.6 depicts both the wall's progress and the number of enemy attacks by week until it was completed. The thick green line shows the wall's progress, the red dots the location of the attacks, and the white numbers in the red box the number of enemy attacks. We should make clear that the wall along Route Gold essentially completed a box around Ishbilyyah and Habbibiyah. Walls on the west and south were already in place, while the 4-10 BCT was building one to the east.<sup>11</sup>

Immediately to 3-4 BCT's east, 4-10 BCT was building another wall to seal off Sadr City from that side. The wall complemented strongpoints held by 4-10 BCT units along their western boundary (the eastern edge of Sadr City). According to Major Rob

<sup>11</sup> Ballagh interview.

**Figure 5.5**  
**M1 Tanks in the Battle of Sadr City**



SOURCE: Colonel John Hort.

RAND RR160-5.5

**Figure 5.6**  
**Progress in Wall Construction and Enemy Contacts by Week, April 18 Through May 22, 2008**

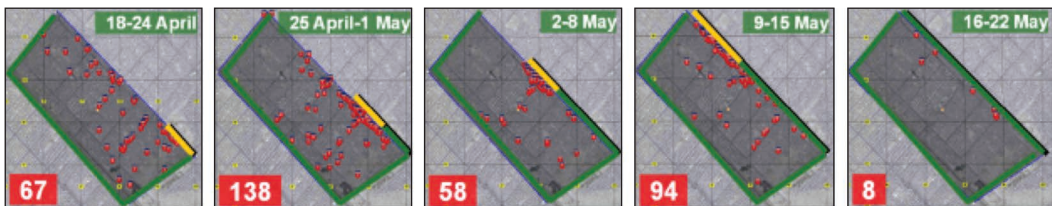

SOURCE: Colonel John Hort, "Lessons Learned," April 24, 2009.

RAND RR160-5.6

Ballagh, then 4-10 BCT's brigade operations officer, they also experienced fierce and frequent attack. Most of the attacks on 4-10 BCT's wall consisted of small groups of three or four fighters. In contrast to 3-4 BCT's effort, 4-10 BCT worked only at night. They did so in part because they had no armored cranes. For whatever reason, they did not experience the same degree of difficulty "commuting" to and from the wall-building effort that had forced 3-4 BCT's units to change their approach.<sup>12</sup>

<sup>12</sup> Ballagh interview.



In 3-4 BCT's area of operations, TF 1-6 IN arrived in Baghdad a few weeks before the Gold Wall was complete. The task force immediately assumed a turn in the wall-building rotation. Major Thompson, the TF 1-6 IN battalion operations officer, remembers an abrupt transition. Obviously, TF 1-68 CAB and the 1-2 SCR were fully consumed by the fighting in Operational Environment (OE) Gold. Consequently, TF 1-6 IN received a brief but thorough orientation to the area of operations and plunged into the fight. Eifler committed Captain Erik Oksenvaag's C Company to the wall-building effort, while Captain Drew Slack's company started fighting in Ishbiliyah.<sup>13</sup> Colonel Hort later emphasized that "TF 1-6 IN played a decisive role in combat operations from 4–15 May. Their arrival, albeit late in the stages of the battle, was critical in relieving some of the pressure on 1-68 CAB and 1-2 SCR, while adding armor and partnership capacity to the Iraqi Security Force."<sup>14</sup>

TF 1-6 IN's pre-deployment training had prepared them well for the intense urban combat they would encounter in Iraq. Lieutenant Colonel Eifler knew that his battalion would probably be operating separately from its parent brigade, but he did not know where. He visited several different locations during his battalion's pre-deployment site survey (PDSS), but none of them were in Baghdad. Because of this uncertainty, Eifler made sure they trained equally hard on combat operations and COIN tasks. Through pure chance, TF 1-6 IN conducted its mission rehearsal exercise at Grafenwoehr, Germany. In contrast to Joint Maneuver Readiness Center at Hohenfels, where most European-based units conduct their pre-deployment certification exercises, there is no mock forward operating base (FOB) at Grafenwoehr. For that reason, the task force practiced operating entirely out of combat outposts (COPs), just as they would during their time in Sadr City.<sup>15</sup>

Strangely, the enemy only chose to fight at the wall's leading edge. Major Gibby found this odd, because a coordinated RPG volley was perfectly capable of knocking out an individual section of T-wall.<sup>16</sup> This may have stemmed from the enemy's organization into sectors running the length of Sadr City, with each sector commander fighting his own battle until exhausted.

## Going After JAM Leaders: The MND-B "Deep Fight"

As intense fighting took place along Route Gold, MND-B headquarters remained focused on attacks against key adversary leaders. This was accomplished by a combination of targeted information operations, air and GMLRS strikes, and special opera-

---

<sup>13</sup> Thompson interview; Brian Eifler, email to M. Wade Markel, Subject: Sadr City Review, November 12, 2010.

<sup>14</sup> Hort email to David E. Johnson, April 27, 2011.

<sup>15</sup> Eifler interview; Thompson interview.

<sup>16</sup> Headquarters, 3-4 BCT, "Lessons Learned"; Hort interview; Gibby interview.

tions forces raids. Except to note that these raids occurred, however, we will not discuss them further because of their classification. Part of the information operations effort focused on insurgent leaders, instilling a well-founded sense of anxiety in them about being killed or captured. Information operations also highlighted the indiscriminate nature of enemy attacks. Meanwhile, concurrent rebuilding efforts sought to make plain that government control offered Sadr City's inhabitants better prospects for the future than did continued JAM domination.

Lieutenant Colonel Frank Zimmerman, MND-B's information operations officer, likened these information operations to a flashlight, contrasting them with more broadly focused efforts pursued by previous MND-B headquarters. Instead of broad, general messages stressing U.S. aspirations for a better future for Iraq under a capable, benevolent Iraqi government, 4th Infantry Division's messages targeted insurgent leaders. Crafted to appeal to all possible audiences, broad messages frequently failed to connect with any target audiences, according to Zimmerman. Their credibility also suffered because reality seldom lived up to the aspirations expressed. In contrast, MND-B's central message to JAM leaders was that U.S. forces knew who and where they were, and were coming to get them. Having reasonably accurate intelligence as to the identity and location of key leaders, MND-B would bombard their neighborhoods with leaflets, hang "wanted" posters, and broadcast the specifics of the offenses for which insurgent leaders were sought.<sup>17</sup>

These information operations efforts often produced the desired result, but sometimes they proved counterproductive, according to our sources. When they worked well, they either led to the arrest and detention of a high-value target or deterred him from returning to his old haunts. On other occasions, however, subjects "went to ground" when the leaflets or billboards warned them they were being sought, causing them to take precautions and evade coalition forces. Finally, the leaflet drops sometimes inadvertently helped intimidate the population on JAM's behalf. Neighborhood residents assumed that if the United States was hunting someone he must be in the area and stopped interacting with U.S. forces for fear of retribution.<sup>18</sup>

The division made sure to highlight JAM's malfeasance as well. JAM rockets often went awry, striking civilian targets instead of places in the International Zone at which they were supposedly aimed. Lieutenant Colonel Steve Stover, the MND-B public affairs officer, worked hard to make sure that such events received extensive local media coverage. In complementary fashion, U.S. forces tried to be extremely discriminate in their fires, firing only against identifiable hostile targets and taking care not to engage when there was a high probability of collateral damage. This discrimination did not necessarily make U.S. forces any more popular. It did, however, manage to convince Sadr City's inhabitants that rocket teams and JAM militiamen were danger-

---

<sup>17</sup> Lieutenant Colonel Frank Zimmerman, telephone interview with M. Wade Markel, March 5, 2010.

<sup>18</sup> Thompson interview.

ous to be around, thereby generating pressure for them to curtail their activities or go elsewhere.<sup>19</sup>

Rebuilding Ishbilyah and Habbibiyah were essential components of General Hammond's plan to restore the government of Iraq's control of Sadr City. Once it became clear that MND-B would probably not get permission to clear Sadr City by force and certainly lacked the resources to do so, General Hammond directed Lieutenant Colonel Gerry Messmer, his civil-military operations planner, to develop a plan to reduce Sadr City nonkinetically. Hammond told Messmer and other subordinates that he wanted the area south of the Gold Wall to be "like Disneyland," contrasting sharply with conditions in areas remaining under JAM's domination. The thought was that residents in Sadr City proper would demand the life they saw developing on the other side of the wall.<sup>20</sup> We will describe the effort in greater detail in the next section, but the important aspect here is that rebuilding commenced while combat along the Gold Wall was still going on. Hammond was looking forward to the point at which non-lethal efforts transitioned from a supporting effort to the main effort.<sup>21</sup> The primary purpose of this civil-military operations effort was not actually about development, but rather about improving short-term security. General Hammond was operating on the assumption that short-term improvements in economic activity took potential insurgents off the street.

MND-B struck its most effective blow against JAM's leadership on May 6, 2008. Few top-tier leaders were left in Sadr City at that point, many having fled before the battle even began. U.S. intelligence revealed that the remaining JAM leaders met periodically in a trailer complex next to the Imam Ali Hospital. General Hammond wanted to strike them the next time they met, so the division staff developed a plan to hit the meeting with GMLRS when they did. Because the missiles would hit close to a hospital, the attack was extremely sensitive and required prior approval from both MNF-I and U.S. Central Command.<sup>22</sup>

On May 6, on receiving confirmation that the remaining leaders had gathered in the trailer complex, Hammond gave the order to strike. Initial reports claimed that the United States had struck the hospital, something Hammond knew to be false because he was viewing the strike through a UAS feed. He was able to quell rumors by flying immediately to the hospital parking lot with accompanying media, showing what had actually been hit and what had not.<sup>23</sup> While several JAM leaders emerged relatively unscathed from the missile strike, most left Sadr City as quickly as possible.

---

<sup>19</sup> Lieutenant Colonel Steve Stover, interview with M. Wade Markel, Fort Meade, Maryland, April 23, 2010.

<sup>20</sup> Hammond interview; Messmer interview, April 26, 2010.

<sup>21</sup> Messmer comments on draft, November 9, 2010.

<sup>22</sup> Hammond interview; Rainey interview; Hort interview.

<sup>23</sup> In fact, the British medical journal *The Lancet* cited this attack as evidence that coalition forces have targeted medical professionals and facilities. See Paul Webster, "Reconstruction Efforts in Iraq Failing Health," *The*

The GMLRS strike proved to be the final straw for JAM's resistance. On May 12, 2008, Moqtada al-Sadr announced a new cease-fire. Al-Sadr's actual reasoning remains opaque, and the sincerity of his offer seemed suspect at the time. Individual JAM elements continued fighting, albeit weakly, as if they had not gotten the word, or were choosing not to heed it.<sup>24</sup> At the time, General Hammond suspected a trap. When Prime Minister al-Maliki ordered the Iraqi Army to plan an attack across Al-Quds street to occupy Sadr City, General Hammond argued strenuously against that course of action. In his view, the Iraqi Army was simply not ready for a difficult fight in urban terrain, unsupported by U.S. forces. Iraqi commanders agreed with Hammond, but al-Maliki ordered the operation to proceed. On May 20, units from the Iraqi Army's 1st and 9th Divisions advanced unopposed into Sadr City, quickly spreading the Iraqi government's grip over the rest of the district.<sup>25</sup>

When asked to speculate as to what led to this surprising result, most of our respondents suspected that JAM had simply exhausted itself. Those fighters willing to fight U.S. forces in open battle had done so, and had either been killed or convinced of the folly of their actions. Mid-level leaders had either been killed or convinced that they soon would be. 3-4 BCT received reliable intelligence that nearly all of JAM's leaders had fled the area of operations by the end of May 2008.<sup>26</sup> The journalist Patrick Cockburn, who has extensive contacts with al-Sadr and within his organization, attributed al-Sadr's decision to a desire to avoid a decisive confrontation when al-Sadr found himself in an extremely disadvantageous position. According to Cockburn, the Iranians had told al-Sadr that they would not back continued confrontation with the U.S.-supported al-Maliki government.<sup>27</sup> In short, it is not clear whether al-Sadr's offer of a cease-fire represented a genuine choice or was merely a gambit to hide the reality that JAM was incapable of further effective armed resistance.

The cumulative effect of the battle and the wall on enemy activity was dramatic. Throughout the battle, no single route clearance patrol had ever been able to clear Route Bama, one of the streets leading up to Route Gold. EFP after EFP would disable first one Husky, then another, at which point a new patrol would have to relieve the first. After the battle, Corey Collings's platoon was able to drive Route Bama in less than thirty minutes. They encountered no IED. No one fired at them.<sup>28</sup>

---

*Lancet*, Vol. 373, February 21, 2009.

<sup>24</sup> Michael Gordon, "In Spite of Truce, War of Attrition over Wall Persists in Sadr City," *The New York Times*, May 15, 2008, p. A6.

<sup>25</sup> Hammond interview.

<sup>26</sup> Bryan Gibby, email to M. Wade Markel, subject: re: Further Inquiries, January 14, 2011.

<sup>27</sup> Cockburn, p. 212.

<sup>28</sup> Collings interview.

## Summary and Conclusions

Originally intended to help the Iraqi Army contain JAM infiltration, building the wall along Route Gold drew JAM into decisive battle on disadvantageous terms. JAM lost hundreds, if not thousands, of fighters trying to stop its inexorable progress that threatened JAM access to the Jamiliyah Market. Meanwhile, aerial surveillance and strike against JAM Special Groups' rocket capabilities beyond Route Gold continued to suppress those rocket strikes. Special operations forces continued to target enemy leaders, further disrupting their command and control capabilities. With much of his military capability shattered, Moqtada al-Sadr offered a cease-fire on May 12, bringing this phase of the battle to a close.

## Exploiting the Success of Battle

---

It is a time-honored maxim of the military art that commanders should exploit tactical success to achieve decisive results. For example, a commander might initiate a pursuit after a battle to capture or destroy disorganized enemy forces in retreat.<sup>1</sup> In this case, U.S. forces exploited their defeat of JAM on the Gold Wall by increasing the intensity of their attacks on JAM's networks, and by launching an ambitious program of reconstruction to transfer the loyalties of Sadr City's population to the government of Iraq. The purpose of this chapter is to describe the kind and degree of efforts to exploit the victory, and to remind readers that such efforts are needed to consolidate success. Without such efforts, JAM might have been able to regenerate itself as it had after the first U.S. offensive in 2004.

There was a synergy between these two efforts. The ubiquity of U.S. forces engaged in reconstruction allowed the local population to provide intelligence without attracting undue attention. U.S. and Iraqi forces exploited this information to kill or capture JAM leaders remaining in Sadr City. Meanwhile, reconstruction efforts strove to foster bottom-up development led by an Iraqi private sector. The purpose of these efforts was to create an alternative locus of power that could stand against JAM. U.S. forces' departure from the area of operations in early 2010 prevents any assessment of the long-term effectiveness of these efforts. In the short term, however, JAM proved incapable of further military operations at any scale.

There is a debate about the degree to which reconstruction actually contributes to success in counterinsurgency.<sup>2</sup> There is also a debate about whether the role of the military in counterinsurgency is to destroy the enemy or to protect the population. Our analysis of the Battle of Sadr City can resolve neither of these questions. We can only describe the efforts undertaken by coalition forces and how conditions in Sadr City evolved. Other analysts can incorporate this research into comparative studies. That having been said, the exploitation phase of the Battle of Sadr City illustrates that the apparent tension between destroying the enemy and protecting the population may

---

<sup>1</sup> Successful exploitation rarely happens, however, because victorious forces are often exhausted by their exertions at the battle's end.

<sup>2</sup> Collier, 2010.

be a distinction without a difference. U.S. forces attacked JAM's networks in order to protect the population. To do so, they organized and operated in certain ways, with certain capabilities under a new set of conditions. Most notably, the government of Iraq started exercising its sovereignty, placing additional constraints on U.S. operations within Sadr City. This case may not provide a template for future operations, but understanding its dynamics and context may help commanders deal with similar situations in the future.

## The Two Components of Exploitation

In the battle's final phase, which lasted from the May 12 cease-fire through the January 2009 provincial elections, U.S. and Iraqi forces exploited JAM's defeat. Within OE Gold, U.S. forces, led by TF 1-6 IN, relentlessly targeted what remained of the Shia insurgent infrastructure. Concurrently, elements of the 926th Engineer Brigade spearheaded a massive reconstruction effort to erode JAM's popular support. Soon, Ishbilyah and Habbibiyah's inhabitants began to provide a flood of information about insurgent activity on both sides of Route Gold. The Iraqi Army apparently had similar success on its side of the wall, although the prohibition on U.S. forces in Sadr City kept U.S. forces from confirming Iraqi reports.

Even before the wall was complete, the rest of 3-4 BCT returned to counterinsurgency operations, albeit at a higher level of intensity. Leaders started engaging with local notables again, and units started patrolling the streets in the day, while acting on that intelligence at night. During this phase, MND-B exploited the security gains to rebuild Ishbilyah and Habbibiyah as part of a concerted effort to show that life under al-Maliki's Iraqi government could be much better than life under JAM had been. Concurrently, MND-B and 3-4 BCT continued relentlessly to identify and kill or capture key JAM and Special Group personnel within their areas of operation. A shortage of interpreters, however, often hindered operations.<sup>3</sup> Although this chapter will discuss these different aspects of the exploitation effort separately, it is important to understand that they were mutually reinforcing and inextricably intertwined.

MND-B employed a unique organization for this purpose. Usually, divisions allocate areas of operation to their subordinate units, which in turn control all friendly activities within that space. 3-4 BCT was fully committed to combat operations in an area of operations extending well beyond Sadr City itself. Within OE Gold, this task fell mostly to TF 1-6 IN. Moreover, 3-4 BCT, like any other BCT, lacked the necessary expertise and capabilities to orchestrate a reconstruction effort of this scope and scale. MND-B's engineer brigade, the 926th, was uniquely suited to the task of reconstruction but was not organized to control combat operations, even if anyone had con-

---

<sup>3</sup> Northrop response to questions, August 14, 2010; Lewis interview.

sidered putting them in charge of operations in Ishbilyah and Habbibiyah. Instead, MND-B organized operations in that area as a division fight in a single brigade area of operation.<sup>4</sup>

### **Maintaining the Pressure**

When the wall was complete, TF 1-6 IN “flipped the switch” to COIN operations. TF 1-68 CAB and 1-2 SCR began to transition out of OE Gold; the former assumed responsibility for other parts of the brigade battlespace, and the latter rejoined 2 SCR in preparation for redeployment. TF 1-6 IN was also hunting the enemy in its area of operations. That area of operations included Sadr City proper, which it still could not enter. Over time, TF 1-6 IN would establish close working relations with both the Combined Joint Special Operations Task Force (CJSOTF) in Baghdad and the 44th Brigade of the Iraqi Army, enlisting their assistance in targeting enemy capabilities beyond TF 1-6 IN’s reach. According to Major Thompson, TF 1-6 IN’s battalion operations officer, 3-4 BCT and MND-B provided a wealth of assets to assist TF 1-6 IN in this effort.<sup>5</sup>

TF 1-6 IN decentralized much of the responsibility and capability for obtaining and acting on intelligence to its subordinate companies. Each company had its own intelligence fusion cell, generally headed by the company fire support officer and an experienced noncommissioned officer who already had several tours in Iraq. Those company fusion cells analyzed intelligence their platoons collected through constant interaction with the population. Throughout the fall of 2008, TF 1-6 IN’s companies constantly maintained one platoon in sector. In practice, this meant between ten to twelve hours on patrol, another four to six hours securing their joint security station, with whatever time remained used for refitting and sleep.

TF 1-6 IN also made good use of its snipers in an economy of force role. The battalion’s snipers provided excellent surveillance, because of their ability to observe a large area but maintain a low signature. Eifler and Thompson thought their snipers contributed more through reconnaissance and surveillance than they did by actually engaging the enemy.<sup>6</sup>

TF 1-6 IN’s intelligence section would then synthesize the resulting information to identify targets within OE Gold and in Sadr City proper. The TF’s leadership would then assess which organization was best suited to kill or capture the target. Sometimes Eifler would pass the information to the CJSOTF for action, while at other times they would pass the information to Colonel Y’s Iraqi Army battalion. This battalion was headquartered in OE Gold, which made coordination convenient, but it could operate

---

<sup>4</sup> Hammond interview.

<sup>5</sup> Eifler interview; Thompson interview.

<sup>6</sup> Eifler email to M. Wade Markel.



in Sadr City proper. Colonel Y made a practice of acting on intelligence tips within fifteen minutes of receiving them.<sup>7</sup>

During this time, TF 1-6 IN also added another wall along Sadr City's northwest side to complement the Gold Wall along Al-Quds Street. JAM did not challenge the construction of this wall along Route Grizzlies with nearly the same intensity that it fought the Gold Wall, though EFPs killed at least two U.S. soldiers during its construction. By the time it was complete, Sadr City was walled in on three sides, but the northeast side would remain open. A canal to the north provided nominal hindrance to enemy traffic, but U.S. and Iraqi forces were stretched too thin to control that avenue of approach effectively.<sup>8</sup>

The danger waned but had not fully disappeared. Eifler's men played a deadly game of cat and mouse with EFPs throughout their tour of duty, although the TF's units encountered most EFPs on major thoroughfares on the area's borders. While the threat from JAM had largely collapsed as a result of the fight for the Gold Wall, a new threat arose. This time, the challenge was the Hezbollah Brigades in Iraq.

The Hezbollah Brigades had been operating in Sadr City for some time, but it had been difficult to distinguish them from JAM.<sup>9</sup> In addition to employing IEDs—particularly those using EFPs—the Hezbollah Brigades used improvised rocket assisted mortars (IRAMs), also known as “lob bombs.” An example of an IRAM is shown in Figure 6.1. A simple, but deadly, device, an IRAM consisted of a large acetylene tank filled with homemade explosives and ball bearings, with a homemade fuse and a 107mm rocket in its base to fire it from its launcher. The range of an IRAM is approximately 200 meters. IRAM launchers were sometimes mounted in the back of dump trucks and covered with trash to conceal them. Figure 6.2 shows such a truck with seven dual IRAM launchers (fourteen IRAMs) after firing.

In July 2008 Hezbollah Brigades launched IRAM attacks at the aerostat at JSS Ur and COP Callahan (see Figure 6.3 for the damage to COP Callahan). U.S. forces mostly escaped serious harm because the Hezbollah Brigades chose poor targets. Additionally, an IRAM detonated prematurely, killing the Hezbollah crew. An identification card recovered from the blast site enabled U.S. intelligence to link the attack to the Hezbollah Brigades.<sup>10</sup>

The enemy also struck, occasionally with deadly effect, at the institutions U.S. forces were trying to establish. In late June, the Iraqi District Advisory Council was to meet for the first time in three years. The meeting's chief purpose was to seat Hassan Shaama, the Council's newly elected head, and was to be attended by John Hort and

---

<sup>7</sup> Thompson interview.

<sup>8</sup> Thompson interview.

<sup>9</sup> Gibby email to M. Wade Markel.

<sup>10</sup> Thompson interview; Bryan Gibby, email to M. Wade Markel, subject: Re: Further Inquiries, dated January 14, 2011.

**Figure 6.1**  
**IRAM**

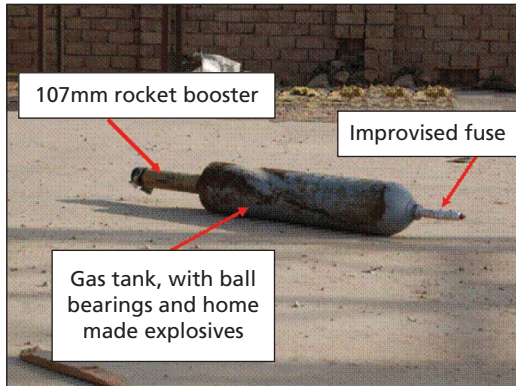

SOURCE: Farris, "Warfighter Observations During the Surge."

RAND RR160-6.1

**Figure 6.2**  
**IRAM Launch Truck**

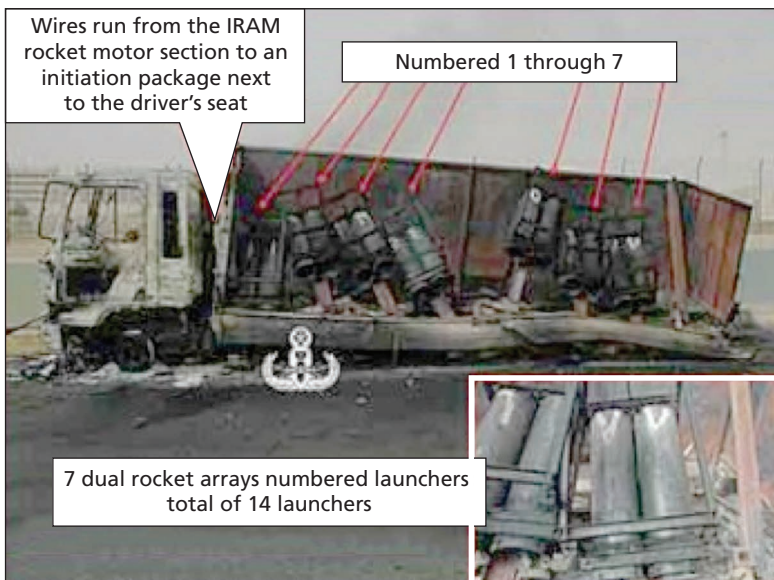

SOURCE: Multi-National Force-Iraq.

RAND RR160-6.2

**Figure 6.3**  
**COP Callahan After IRAM Attack**



SOURCE: Farris, "Warfighter Observations During the Surge."

RAND RR160-6.3

the State Department's deputy chief of mission in Iraq. Shortly after the meeting was scheduled to start, but before Colonel Hort and the State Department officials he was escorting arrived, a bomb went off, killing several Iraqis and four Americans. Among the dead were the chief of the BCT's State Department liaison team and a U.S. Army engineer. Hassan Shaama was badly injured.<sup>11</sup>

<sup>11</sup> Because of Shaama's importance to the establishment of stability in OE Gold, U.S. commanders secured an exception to policy to allow him to be treated in U.S. facilities. The description of events and their aftermath is taken from the Thompson interview and Alissa J. Rubin and Mudhafer al-Husaini, "Baghdad Blast Kills Four Americans," *The New York Times*, June 25, 2008.

Meanwhile, MND-B continued its information operations campaign. The division erected billboards in its area of operations, and at U.S. commanders' urging, Iraqi security forces disseminated handbills emphasizing various coalition messages. MND-B considered these efforts so important that it used unmanned aerial vehicles to monitor them. Finally, key leader engagements continued at an intense pace throughout the operation. Feedback from Iraqi citizens indicated that these operations had considerable effect.<sup>12</sup> On the other hand, one can hardly imagine Iraqis telling coalition forces that any coalition efforts were ineffective or counterproductive. As with the rest of the Sadr City operation, information operations were clearly important to U.S. military leaders, but their actual contribution to the outcome is very hard to assess.

By October 2008, the situation in Sadr City had stabilized considerably. In August, 3-4 BCT, with help from other U.S. forces, captured the planning cell for the IRAM attacks. This capture largely neutralized the Hezbollah Brigades in the BCT's area of operations. Ironically, some key JAM leaders like Tahsin al Faraji and other JAM leaders' henchmen picked that time to start returning. U.S. forces managed to capture many of these returning adversaries.<sup>13</sup> As noted, U.S. forces still encountered EFPs on their way to and from OE Gold, but experienced very few attacks within it. U.S. targeting of JAM's leadership reached its maximum effectiveness in December 2008 in the run-up to the elections, which transpired without incident in late January 2009.<sup>14</sup> Eifler's men transitioned from their tanks and infantry fighting vehicles to MRAPs.

Operations became more difficult thereafter due to the implementation of the status of forces agreement, but did not cease. The major change imposed by the agreement required U.S. forces to get a warrant from an Iraqi judge before detaining a suspect. Initially, all the judges in whose jurisdiction Sadr City fell flatly refused to issue warrants, probably fearful of JAM's reprisal. Eventually, one of TF 1-6 IN's company fire support officers found an Iraqi counterterrorism judge who was willing to hear such cases. Because TF 1-6 IN had been careful about the evidence it offered to support its requests for detention orders, the judge approved almost all of its requests, sometimes hearing evidence for up to eighteen hours in a row at a joint security station.<sup>15</sup>

### **Exploiting Success Through Reconstruction**

Reconstruction was a central part of 3-4 BCT's effort to restore security to Sadr City, and an important focus for the brigade staff. U.S. forces had killed, wounded, or captured thousands of militiamen and denied JAM access to its principal source of revenue, the Jamiliyah Market. With these measures, 3-4 BCT and MND-B had loos-

---

<sup>12</sup> Frank Zimmerman, memorandum to authors, undated.

<sup>13</sup> Gibby email to M. Wade Markel.

<sup>14</sup> Thompson interview.

<sup>15</sup> Thompson interview.

ened JAM's hold on the population of Sadr City, especially the sections of Ishbilyah and Habbibiyah. General Hammond felt MND-B needed to transfer the population's loyalties to the government of Iraq through an ambitious program of reconstruction. General Hammond's direction to his subordinates was to make Habbibiyah and Ishbilyah "look like Disneyland." He also hoped to further erode JAM's support on the population north of Route Gold by creating a marked contrast between life under JAM's de facto jurisdiction and life under the government of Iraq. Hammond's concept required parallel and complementary efforts in the same area of operations by 3-4 BCT and elements of the 926th Engineer Brigade, both operating under division control.

In the short term, these efforts correlated with increased coalition control over Sadr City. The research team was unable to assess the long-term success of these efforts, however. U.S. withdrawal from the area in early 2010 essentially eliminated any outside observation and data on conditions in the area. We describe these efforts because our respondents believed them to be important and effective, in consonance with U.S. counterinsurgency doctrine.

According to Colonel Hort, the BCT's subordinate battalions, especially TF 1-6 IN, were energetic and imaginative in finding local solutions to local problems. As with so many other elements of this battle, 3-4 BCT was able to draw on the experience of its predecessor, 2-82 BCT. For example, microgeneration was an important part of TF 1-6 IN's effort to foster bottom-up economic development. It was also an approach that 2-82 BCT employed successfully in Adhamiyah. The brigade's efforts established the framework in which more ambitious efforts at reconstruction took place.<sup>16</sup>

Colonel Hort also recalled that at the beginning of the Battle of Sadr City he had no engagement with the local civilians. At the "end and during reconstruction efforts, we had over 70 local sheiks and the entire Sadr City district working hand in hand with the BCT leadership and the Iraqi Army."<sup>17</sup>

Reestablishing the Jamilyah Market, parks, and schools within OE Gold helped deny potential rocket launch sites to the enemy. Major Thompson theorized that it became problematic for JAM to use such launch sites because doing so could either endanger children at school or play, cause the facility to be shut down, or both. For whatever reason, Thompson remembers no confirmed rocket launches from either Ishbilyah or Habbibiyah during the battalion's tour in Sadr City.<sup>18</sup>

Much of the task force's focus concerned using microgrants of \$2,000 or less that commanders could dispense with a minimum amount of paperwork to foster economic development. Though they sometimes functioned as compensation for damage, locals were supposed to use them to improve their business, not simply recoup their

---

<sup>16</sup> Hort email to David E. Johnson.

<sup>17</sup> Hort email to David E. Johnson.

<sup>18</sup> Thompson interview.

losses. Across the board, commanders found these to be especially useful.<sup>19</sup> Eifler's TF 1-6 IN was considered fairly successful in distributing and administering these grants. As with the 926th Engineer Brigade's reconstruction efforts, TF 1-6 IN's program depended on close and continuous interaction with the locals, and Eifler's people thus knew who would put the grants to good use. Once company commanders and platoon leaders identified a potential recipient, they helped them through the entire process with an eye toward enabling the grantee to succeed.<sup>20</sup>

In conjunction with the brigade medical company, Eifler's battalion also conducted several cooperative medical engagements in Habbibiyah and Ishbilyah, as did the other battalions under 3-4 BCT's control during this period. All told, brigade elements conducted twelve such engagements.<sup>21</sup>

Eifler's efforts complemented those of the U.S. Army Reserve's 926th Engineer Brigade, commanded by Brigadier General Jeff Talley. Even before fighting along the Gold Wall had stopped, the 926th had started rebuilding Ishbilyah and Habbibiyah. Known to the Iraqis as "Mohandas," which translates as "the Engineer," Talley had considerable prestige with Iraqi government officials. A reservist, Talley held a Ph.D. in engineering and was a tenured professor at Notre Dame University in civilian life, a credential that carried immense weight with the Iraqis and signified unique capabilities within the U.S. Army. Talley had arrived in Iraq in April 2008 with a novel concept of targeted engineering effects. Before his unit's deployment, Talley had studied the relationship between reconstruction efforts in Iraq and violence, coming to the conclusion that declines in violence tended to correlate with effective, focused reconstruction activity. Thus, Talley's concept was to employ reconstruction efforts primarily to reduce violence rather than to address the greatest infrastructure needs. To be sure, this shift in emphasis was often academic because the areas with the most violence also tended to be areas with the greatest needs.<sup>22</sup>

Talley got right to work in Sadr City. Within five days of the wall having extended in front of the Jamiliyah Market, the 926th had cleared an overflowing river of sewage that had befouled the market area for years. JAM leaders had used this running eyesore as evidence of the government's indifference to the plight of Sadr City's residents, and were loath to see this symbol removed.<sup>23</sup> By June, the market was operational again. By August, it had reached its peak capacity, with trucks arriving and departing from all over Iraq. U.S. forces were proud of their efforts in restoring the marketplace, though

---

<sup>19</sup> Bradford interview; Pappal interview; Eifler interview.

<sup>20</sup> Hort interview; Eifler interview.

<sup>21</sup> Hatcher email, 2011.

<sup>22</sup> Hammond interview; Talley interview.

<sup>23</sup> Talley interview.

the market's appearance usually failed to impress distinguished visitors unless they were shown "before" pictures of the market's burned-out state in May.<sup>24</sup>

Rebuilding Sadr City for its citizens was half of Talley's vision. The other half was the concept of social entrepreneurship, in which Talley emphasized fostering Iraqi private-sector capacity to meet Iraqi needs. Talley and his soldiers would teach, coach, and mentor Iraqi entrepreneurs to establish small and medium-sized businesses to do the actual work of reconstruction (Figure 6.4). In Talley's view, this created a class of people with a substantial stake in the emerging social and political order and was the quickest way to jump start local economies.<sup>25</sup>

Civilian-acquired skills made the 926th's soldiers uniquely well-suited to the task of reconstruction. A significant proportion of the brigade's soldiers were certified professional engineers. One sergeant first class was Alabama's supervisor of highways in civilian life. Equally important, a great number were also small businessmen. Whether self-employed or otherwise, most had experience with U.S. government contracting rules and procedures, which greatly accelerated reconstruction and capacity building. These skills proved exceptionally useful in expediting contracting and construction work at a time when speed was of the essence.<sup>26</sup>

Talley's soldiers helped Iraqis start construction, transportation, and garbage-collection companies. One of the more important initiatives, however, was electricity microgeneration cooperatives. Iraq's electricity generation and distribution problems had proven largely intractable over the prior five years. Moreover, JAM effectively barred external actors from Sadr City. JAM had provided electricity from portable generators at a high price, cornering the market and getting revenue in the process. With JAM at least temporarily neutralized, Talley promoted electricity microgenera-

**Figure 6.4**  
After the Battle Reconstruction and Cleanup



SOURCE: Provided to the authors by 4th ID.

RAND RR160-6.4

<sup>24</sup> Thompson interview.

<sup>25</sup> Talley interview.

<sup>26</sup> Talley interview.

tion companies with whom neighborhood and district councils would contract to provide electricity at a subsidized price. The charged rate undercut what JAM was able to offer, depriving them of an important source of revenue at the same time that Talley's initiative helped create a rival business class.<sup>27</sup>

JAM's leaders understood the consequences of coalition reconstruction efforts. According to Talley, Moqtada al-Sadr issued a *fatwa* declaring anyone who worked with the Americans to be apostate and thus liable for execution. This was not an idle threat. Over the course of the summer, JAM killed several hundred of Sadr City's inhabitants, often for collaboration with the Americans. Hitherto reliable, capable contractors would quit, citing death threats against themselves or their family if they gave any notice or explanation at all; many simply did not show up to work. More, however, braved the threats, whether because the potential reward was too lucrative or because JAM's threats had finally tried their pride beyond the breaking point.

Al-Sadr's *fatwa* quickly backfired. Even some of Sadr City's more fundamentalist, anti-American inhabitants had a hard time accepting that working to improve community living conditions with the Americans was impious, let alone so impious as to merit death.<sup>28</sup> Eventually, al-Sadr withdrew the *fatwa* and pressure became less overt.

Besides the enemy's predictable efforts at sabotage, MND-B's greatest challenge was getting the government of Iraq to assume meaningful responsibility for maintaining security and providing essential services within Sadr City. To some degree, this reluctance stemmed from internecine rivalry among Shia factions. After the Sadrist Trend withdrew its support for the al-Maliki government, many of the remaining Shia government officials owed their allegiance to either ISCI (Islamic Supreme Council of Iraq) or the Da'wa party, both of which viewed al-Sadr's erstwhile supporters in Sadr City as adversaries.

General Talley had to work hard to get Baghdad's governor to assume responsibility for trash pickup. It wasn't that the governor had anything against Sadr City; he simply didn't set great store on refuse removal in any context. It was only after Talley managed to demonstrate how clean streets were safer streets, because insurgents could not hide IEDs among the refuse, that the governor understood its urgency. Eventually, the al-Maliki government dedicated about \$100 million of its own resources to rebuild Sadr City beyond Al-Quds Street under the direction of Dr. Samaad, a close friend of Prime Minister al-Maliki's and an official widely respected for his courage and integrity.<sup>29</sup>

The reconstruction effort's operational results frankly surprised MND-B leaders. General Talley had predicted to General Hammond that if efforts succeeded as well as hoped, they might start generating a steady volume of useful intelligence within

---

<sup>27</sup> Talley interview.

<sup>28</sup> Talley interview.

<sup>29</sup> Talley interview; Hammond interview; Messmer interview, April 26, 2010.



a couple of months. In fact, within a couple of weeks Sadr City's inhabitants began providing a flood of tips. For example, an Iraqi teenager began providing photos of IEDs that he took on his cellphone camera while riding around Sadr City on his motor scooter. Residents identified bomb-makers and facilitators. U.S. and, increasingly, Iraqi forces would act on that intelligence. In June and July, Iraqi security forces captured two or three large caches in Sadr City proper, including one operation that they conducted on their own initiative.<sup>30</sup> Successful offensive operations to seize insurgent leaders added further to the confidence and sense of moral ascendancy of the Iraqi security forces.<sup>31</sup>

It is almost certainly too simplistic to attribute the improvement in human intelligence to a well-executed reconstruction effort. It seems clear that the pervasive U.S. presence on the streets of Ishbiliyah and Habbibiyah helped a lot; U.S. soldiers were everywhere, meeting with local officials, surveying damage, supervising and conducting reconstruction activities. This pervasive presence meant that an Iraqi no longer had to expose himself conspicuously to pass useful information along. That presence concurrently limited JAM's ability to move about and intimidate locals.<sup>32</sup>

Iraqis still took a substantial risk in cooperating with U.S. forces. General Talley estimates that hundreds lost their lives as victims of JAM reprisals and indiscriminate terror attacks. The teenager with the cellphone camera was one of those killed. Though JAM could continue to threaten and even kill, however, they could no longer guarantee their threats or even protect themselves.<sup>33</sup> Given the newly established coalition ascendancy, the hunter risked becoming the hunted when he issued a threat. Regardless of whether Sadr City's inhabitants saw their future lying with the U.S. or Iraq's government, they no longer took JAM predominance as inevitable. Sadr City's population began to have a stake in the new order. Increasingly, the population was able to see more permanent progress, and as conditions improved, the local citizenry became invested in maintaining their security and began providing intelligence to Iraqi and U.S. forces.

### ***Iraqi Security Forces: The Police Step Up***

Iraqi security forces continued to develop during this period as well (Figure 6.5). Their progress proved difficult to assess, however. The 44th Brigade of the Iraqi Army, which was jointly responsible for Sadr City with TF 1-6 IN, operated mostly beyond Al-Quds Street. Consequently, TF 1-6 IN found it difficult to observe, mentor, and assess their proficiency. The major development during this period concerned the Iraqi police.<sup>34</sup>

---

<sup>30</sup> Bryan Gibby, comments on draft. Thompson interview.

<sup>31</sup> Talley interview.

<sup>32</sup> Talley interview.

<sup>33</sup> Talley interview.

<sup>34</sup> Thompson interview.

**Figure 6.5**  
**Iraqi Security Forces**



SOURCE: Provided to the authors by the 4th Infantry Division.

RAND RR160-6.5

Before the March offensive, the police in Sadr City had functioned basically as one of JAM's arms. Once the fighting commenced, police had either deserted in droves or even joined the JAM fighters. As a result, the al-Maliki government either fired or transferred them. The Iraqi government replaced them with newly recruited officers, and some transferred in from other parts of Baghdad. Neither the American nor the Iraqi armed forces trusted these new police much more than they had their predecessors. The police remained largely confined to their stations and barracks for quite some time, lest they be shot by the Iraqi Army.<sup>35</sup>

The 44th Brigade was finding it increasingly difficult to both man its checkpoints and conduct the mobile, offensive operations that it needed and wanted to execute. For a while, TF 1-6 IN helped mitigate this tension by manning Iraqi Army checkpoints within OE Gold to enable 44th Brigade soldiers to participate in mobile, offensive operations. In the long term, this solution was obviously untenable. Colonel Eifler thus began to urge General M, the brigade's commander, to supplement his forces with the Iraqi police in order to free up his own manpower. By the end of March 2009, as TF 1-6 transitioned out of the immediate operational environment, the police were coming into their own.<sup>36</sup> More importantly, as the battle subsided, a new reality became apparent to Iraqis living south of ("below") the wall along Route Gold. First, Iraqi Army and national police forces were in place and providing security. For residents, this harkened back to pre-Operation Iraqi Freedom days: Iraqis were now in charge, and not the coalition forces that would eventually leave Iraq.

### ***Provincial Elections***

The January 2009 elections passed without major event in Sadr City. Moqtada al-Sadr's political movement still won the majority of votes in the district, but the streets were largely quiet before and after the election. The game of EFP cat and mouse, how-

<sup>35</sup> Thompson interview.

<sup>36</sup> Thompson interview.

ever, persisted. By March 2009, when TF 1-6 IN turned over to the 2nd Squadron, 5th Cavalry Regiment, JAM's military capacity still seemed to be exhausted, although IEDs remained a constant problem. When JAM did launch another offensive in March 2009, it was largely ineffectual.<sup>37</sup>

## Summary and Conclusions

Even after Moqtada al-Sadr offered his truce on May 12, 2008, the Battle of Sadr City was not over. It simply moved on to another phase. U.S. forces led by TF 1-6 IN intensified efforts to dismantle what remained of JAM's network after the battle. On the other side of Route Gold, Iraqi forces did the same. 3-4 BCT never eradicated JAM completely, but they did manage to neutralize it and prevent it from reconstituting an effective military capability. Reconstruction operations also played a major role in U.S. plans. MND-B's concept envisioned fostering a robust private sector in order to create a counterweight to the Sadrist Trend, but struggled to gain support and traction from the government of Iraq. Increased U.S. reconstruction efforts correlated with reduced violence and increased actionable intelligence from the local population. Too many things were going on at once for this study to establish causal relationships between reconstruction and the reduction in violence, but our respondents certainly believed them to be linked. In any case, the net result was an increase in security for the population and the reduction, if not elimination, of resistance to the government of Iraq and coalition forces.

---

<sup>37</sup> Thompson interview.

## Assessing the Outcome of the Battle

---

In this chapter we explain how the circumstances and events described in Chapters Two through Six shaped the battle's outcome. We identify the five factors that were most important in achieving this result, listed below:

- The U.S. Army's ability to gather and exploit real-time data in the fight against the rocket teams.
- Building the wall along Route Gold, thereby forcing the enemy to fight at a disadvantage.
- The U.S. reconstruction effort, which further eased JAM's hold on the population.
- The Iraqi Army's newly acquired ability to operate independently.
- JAM's mistakes and vulnerabilities.

This analysis informs the insights to be enumerated in Chapter Eight. Put another way, this chapter explains why and how U.S. forces won the battle, while Chapter Eight will derive implications from that experience for the future of the U.S. Army.

### Sadr City in the Aftermath of the 2008 Battle

Perhaps the greatest significance of the Battle of Sadr City lies in what did not happen. Neither the government of Iraq nor Multi-National Force–Iraq had to divert significant forces from the ultimately successful reconquest of Basra. In spite of a shaky beginning, Iraqi security forces did not collapse. U.S. forces did not allow themselves to be drawn into a grinding, grisly battle of attrition in Sadr City, in which the consequences of a bloody victory may well have approached those of defeat and would likely have reinforced Moqtada al-Sadr's hold on the population. Finally, Moqtada al-Sadr did not prevail in his violent attempt to destabilize the al-Maliki government.

Instead, the Iraqi government established effective control of Sadr City for the first time since the U.S. invasion.<sup>1</sup> The Iraqi Army gained confidence in itself and

---

<sup>1</sup> In fact, Saddam Hussein's grip may not have been much firmer. Many U.S. officers told us that even Saddam had been reluctant to send his Army and officials into Sadr City.

moral ascendancy over JAM. The battle identified Iraqi Army leaders who could—and would—fight, thus enabling the government to replace ineffective officers. As a paramilitary force and a political movement, JAM in Baghdad had largely spent itself. In a telling vignette, a Sadr City woman approached the nearly abandoned JAM headquarters after the battle to complain about a brothel that had established itself near her home. The surly young men inside told her to “Go ask the Army. We’re civilians now.”<sup>2</sup> Al-Sadr’s cease-fire was probably the best possible face he could put on the inevitable.

The battle’s long-term significance is more difficult to assess. U.S. forces never went beyond Route Gold in the first place; they left Iraq’s cities in the summer of 2009. Western journalists rarely venture into Sadr City. Overall, we know relatively little about developments there since the battle itself. Attributing what we do know to specific causes is even more difficult.

Nevertheless, the battle’s long-term, strategic results also appear to be relatively positive. The al-Maliki government’s strong stand there and in Baghdad helped propel al-Maliki’s nonsectarian, nationalist “State of Law” coalition to victory in provincial elections in 2009. As of this writing, the Sadrist do not appear to have reasserted their dominance over the eponymous district. An October 2010 *New York Times* article noted that “the neighborhood is now fomenting a mix of secular and religious life that is both ad hoc and infectious.” The government’s ability to provide security and maintain control appears to remain strong.<sup>3</sup>

A note of caution, however, is in order. The battle’s human consequences were significant. According to the British medical journal *The Lancet*, municipal officials in Baghdad estimate that the fighting killed 925 people and wounded 2,605, an estimate that does not distinguish combatants from noncombatants.<sup>4</sup> Based solely on our interviews, these figures seem low. In part, the current minimal level of violence in Sadr City may stem from the fact that the Sadrist are winning at the ballot box what they could not win in battle. Finally, few people who have left Sadr City chose to return after the battle. Only about 1 percent of the internally displaced persons returning to Baghdad have chosen to return to Sadr City.<sup>5</sup>

The 2010 elections did not reward al-Maliki’s State of Law coalition nearly as well as the 2009 provincial elections did. These results are attributable in no small part to the al-Maliki government’s perceived corruption and disappointing results outside the security sector. Al-Sadr’s candidates made a strong showing in Baghdad, garnering

<sup>2</sup> David Enders, “Behind the Wall: Inside Baghdad’s Sadr City,” *Virginia Quarterly Review*, Vol. 85, No. 3, p. 135.

<sup>3</sup> John Leland, “Baghdad’s Shiite Heart Beats Freely as War Ebbs,” *The New York Times*, October 30, 2010, p. A1.

<sup>4</sup> Webster, “Reconstruction Efforts in Iraq Failing Health,” p. 620.

<sup>5</sup> United Nations High Commissioner for Refugees, Iraq Operation, “Monthly Statistical on Return,” January 2011.

17 of the governorate's 67 seats in parliament.<sup>6</sup> Furthermore, al-Sadr became a "king-maker" when he returned to Baghdad in 2011 and gave his support to Prime Minister al-Maliki, thus enabling him to form a government.<sup>7</sup> Thus, al-Sadr may have lost a military battle, but is still a player in the political war.

On balance, this admittedly ambiguous outcome must count as a qualified success, even if highly qualified. The Sadrist clearly ended the battle in a worse military position than when they started, and do not appear to have regained their former pre-eminence. It is difficult to explain their conclusion of a truce on disadvantageous terms on any other basis. If the battle did not worsen their political position substantially, it certainly did not improve it.

## Why Coalition Forces Prevailed

This successful outcome in Sadr City was far from inevitable. JAM clearly intended and expected its uprising in Baghdad to derail the government of Iraq's upcoming offensive in Basra and further discredit the al-Maliki government. Though the security forces as a whole held, elements did collapse under pressure. Some even went over to the enemy. The population did not rise in anger at the foreign invaders. Most importantly, MND-B did not allow itself to get drawn into a bloody, inconclusive battle in the streets and mujallahs of Sadr City.

Five factors decided the outcome in the 2008 Battle of Sadr City. First among them was the U.S. Army's tremendous capability to gather and exploit information in the fight against the rocket teams. Without advance notice or inside intelligence about impending launches, 3-4 BCT was able to acquire, track, and engage JAM Special Group launch teams so responsively and with such reliability that the brigade deterred the enemy from attempting further attacks. The other possibility, of course, is that the BCT managed to kill nearly all of them using the strike and ISR assets allotted to it. 3-4 BCT simply could not have stopped the rockets without these capabilities. The government of Iraq would not allow U.S. ground maneuver elements to advance beyond Route Gold. More importantly, as noted by Colonel Jim Rainey, the MND-B division operations officer, MND-B simply lacked the capacity to do so. Depriving JAM of its offensive capability secured the initiative for coalition forces and the government of Iraq; JAM was isolated within Sadr City. JAM barricaded within Sadr City was a serious problem, but one that MND-B and the government of Iraq could address at a time and in a manner of their choosing.

We do not know whether U.S. forces could have controlled rocket launches in Habbibiyah and Ishbiliyah using airborne ISR and strike assets alone, as they did in

---

<sup>6</sup> Dawisha, p. 36.

<sup>7</sup> Michael Boyle, "What Moqtada al-Sadr's Return Means," *The Guardian*, January 11, 2011.

the area beyond Route Gold. We know that they did not have to; controlling those sites with ground maneuver forces was always central to the plan. It is safe to say that U.S. forces could not have neutralized the rocket launches without the airborne ISR and strike assets. Even at the height of the battle, the al-Maliki government never relented on its decision to exclude U.S. forces from Sadr City beyond Route Gold. More importantly, the coalition lacked the maneuver forces to seize those sites. As this account of the battle shows, MNF-I had to reallocate a part of its reserve and draw units from elsewhere in Baghdad and Iraq just to hold Ishbilyah and Habbibiyah. As their attack to Route Gold shows, the Iraqi Army was not yet ready for an attack against determined opposition either. To secure the launch sites using ground maneuver alone would have forced MNF-I to pull still more units from other parts of Iraq, perhaps derailing the Basra offensive after all.

It is important to point out, moreover, that 3-4 BCT's success in the counter-rocket fight did not require the brigade's leaders to share a deep, contextualized understanding of Sadr City, the Sadrist Trend, or JAM. In the context of the battle of Sadr City, the relevant fact about the enemy was that the range of 107mm rockets fired at the Green Zone extended slightly beyond Al-Quds Street, and that the rocket required a relatively open space for launch. Additionally, U.S. intelligence assets were able to acquire fairly precise, if partial, information about some insurgent leaders and networks that enabled their targeting.

Although we could find few references to a detailed, comprehensive order of battle or organizational structure for JAM, official strength estimates for JAM fighters in Sadr City ranged between 2,000 and 4,000—a fairly wide margin. At the time, U.S. officials surmised that JAM's offensive was tied to the government's offensive in Basra, but the precise nature of that connection never became clear, nor did it seem important. Some U.S. officers, like Bryan Gibby and John DiGiambattista, did display a fairly sophisticated understanding of enemy dynamics. By and large, however, this understanding was sporadic and, more importantly, unnecessary for ultimate success. It is difficult to see how better understanding of JAM could have improved much on the half-minute or so it took 3-4 BCT to acquire and track JAM's rocket launch teams.

The brigade's impressive technical capabilities did have one drawback with regard to understanding the larger threat situation. Outside the context of the direct-fire engagement, it proved very difficult to identify or target important technical personnel, financiers, or leaders of the rocket cells. Early in the fight it became clear that within 30 seconds of a detected launch, BCT assets had to acquire a visual identification for any chance to engage the rocket team's personnel. Because this was almost exclusively reactive, the brigade employed a great deal of its intelligence collection and analytic capability to identify and track these threats in real time. This was largely a successful, if non-doctrinal, solution to the target identification problem. The tradeoff

to achieve this was a reduced capability to analyze the enemy's motives, intentions, and vulnerabilities. There simply were not enough analysts to do both tasks.<sup>8</sup>

Second, building the wall along Al-Quds Street forced the enemy to fight, and fight at an enormous disadvantage. Somewhat unknowingly, at least at first, 3-4 BCT created a situation with the wall that threatened JAM's access to Habbibiyah's and Ishbilyah's human and financial resources as well as their hold on the rest of Sadr City. The wall threatened not only JAM's status, but its members' lives and freedom. Given the increasing facility with which U.S. forces were able to pinpoint and target insurgent leaders, being fixed within Sadr City threatened to make it simply a matter of time before they were killed or apprehended. According to Mao Zedong, the people are the sea in which the guerilla fish swims. That medium loses much of its protective power when the sea is confined to a barrel made of concrete barriers—and when ISR and strike assets put a top on the barrel.

Third, the U.S. reconstruction effort, with Jeff Talley's emphasis on bottom-up entrepreneurship and expanding social capital, helped create a new social and political order to fill the vacuum left by JAM's defeat. It also provided a rough legitimacy to a pervasive U.S. and Iraqi presence that drove JAM deep underground, at least what remained of it, and enabled Sadr City's inhabitants to share intelligence without a prohibitive fear of retribution.

Fourth, the Iraqi Army held, and grew stronger throughout the battle. Had JAM defeated the 3rd Battalion, 42nd Brigade, and maintained its moral ascendancy, a U.S. victory would have meant little. U.S. forces were destined to pull out after the elections, and JAM would simply have resumed its dominance over the district. As it was, the Iraqi Army believed it had fought JAM and beaten it. Certainly, the Iraqi Army was more than a match for what remained of al-Sadr's militia once the latter had impaled itself trying to defeat U.S. armor with flesh and small arms.

It took leaders like Major Mark Rosenberg, Lieutenant Colonel Mike Pemrick, and the Iraqi Army 42nd Brigade's Brigadier General X to stabilize the situation. Colonel Hort later recalled that:

arguably the key lesson learned from the entire battle was the BCT's focus on partnership. A belief championed by General Petraeus, proved instrumental in the overall success of the Battle for Sadr City and the post conflict reconstruction efforts. Every member of the team believed in making the ISF and the Sadr City governance work for their people. From the 11th IA Cdr to the Iraqi platoons we stayed on them and with them every step of the way. Mike Pemrick, my DCO, I would call the poster child in partnership. He in many situations pulled the Iraqi Army forward and wouldn't let them quit. His efforts as well as the rest of the BCT

---

<sup>8</sup> Gibby, comments on draft.



Soldiers created true long term success and coincidentally reestablished civilian confidence with the Iraqi Army and their local governing body.<sup>9</sup>

Fifth, JAM miscalculated badly. Clearly JAM's leaders anticipated that a few days of uprising would divert the impending government offensive to retake Basra. When the initial wave of assaults failed to achieve that objective, there seemed to be no Plan B. Al-Sadr's first announcement of a cease-fire, six days after the fighting began, seems to indicate an attempt to cut his losses in a failed gambit. The fighting had escaped his control, however, and his subordinates were no longer fighting for his cause but rather for their own lives and status. At that point, the battle followed its own inexorable logic until JAM in Sadr City had effectively destroyed itself.

On top of their military miscalculation, JAM handled the politics poorly. Several of our respondents testified to a deep weariness among Sadr City's population of JAM's dominance. The International Crisis Group's reporting also indicated a mounting crisis of legitimacy for the Sadrist movement before the battle was joined. While JAM's leaders may have hoped that a battle would inspire mass resistance among the people, it seemed to provide an opportunity for many of those people to desert the cause instead.

Beyond the miscalculation, the Sadrists handled the battle of perceptions badly. Indiscriminate firing from the middle of populated areas endangered civilians, both those on the receiving end of a wayward missile, as well as those who might be nearby when U.S. forces attacked. The Sadrists were then unable to respond to video footage of the damage their actions had caused. Similarly, their scattergun threats and casual terror against Iraqis collaborating in reconstruction alienated many of the very people upon whom they relied for support. For the people of Sadr City, JAM became "mad, bad, and dangerous to know," as Oscar Wilde once described Lord Byron.

We should also note that JAM had substantial vulnerabilities as a military organization. To be sure, they had numbers, organization, and motivation. Certainly their repeated and futile attacks on U.S. forces building the Gold Wall demonstrated an impressive commitment to their cause and their leaders. As we have observed, however, their tactics were often poor. They demonstrated no ability to synchronize heavy weapons like their 120mm mortars with ground maneuver. In fact, they demonstrated little maneuver capability, at least in the way that U.S. forces might recognize. They showed no ability to interfere with U.S. communications or to counter the ubiquitous UAVs on which U.S. forces depended so heavily in the counter-rocket fight. U.S. forces may not be so fortunate in future engagements with hybrid or irregular opponents.

Above all, the time was ripe for change. In late 2004, Sadr City's inhabitants had exchanged Saddam Hussein's oppressive dictatorship for an unwelcome U.S. occupation. Given Mohammed Sadiq al-Sadr's revered memory, fealty to his son and adherence to an Islamic social order probably seemed like a social and political principle

---

<sup>9</sup> Hort email to David E. Johnson.

worth fighting for, but after three years of living under the Sadrist Trend, disillusionment seems to have set in for many in Sadr City. In 2004, Iraqi forces were just getting started; the army and the U.S. effort to develop it had been reorganized several times since. Leaders were untried, and often unreliable. By 2008, the Iraqi Army had some degree of continuity under its belt, and a respectable cadre of junior and some senior leaders to lead it. And, in 2004, most U.S. ground forces had little experience with or exposure to information-enabled operations. UASs were a novelty even at strategic levels. But by the time the battle of Sadr City began in 2008, 3-4 BCT and its subordinate units had gained considerable experience in integrating UASs and attack helicopters to conduct strike operations integrated with maneuver. In the end, time turned out to be on the U.S. side.

We should also mention that the U.S. forces committed to this battle had prepared for this kind of fight. 1-2 SCR had prepared for an “above the ground” role as a theater reaction force. TF 1-68 CAB units had completed Table VIII mounted gunnery, an exercise over and above those required for deployment to Iraq. TF 1-6 IN had similarly prepared to function as a theater reserve, emphasizing mounted combat to a greater degree than units intended to pacify a specific area of operations. More than mere luck, these preparations were something less than policy, however. As we have detailed, theater policy, reflected in the program of instruction at MNF-I’s COIN Academy, emphasized stability operations and restraint. Ergo, unit commanders either undertook this training on their own or in consultation with their immediate superiors. Lacking a point of comparison, i.e., a unit that had not prepared in this manner but nonetheless found itself committed to fierce urban combat, we cannot assess the difference these preparations made with any degree of precision. Nonetheless, it seems significant that all of the battalion-level units committed to this particular battle had trained for just this sort of operation.

## Summary and Conclusions

Five factors contributed most to the U.S. victory in Sadr City. Those factors were:

- The U.S. Army’s ability to gather and exploit real-time data in the fight against the rocket teams.
- Building the wall along Route Gold, thereby forcing the enemy to fight at a disadvantage.
- The U.S. reconstruction effort, which further loosened JAM’s hold on the population.
- The Iraqi Army’s newly acquired ability to operate independently.
- JAM’s mistakes.

This list by no means exhausts the circumstances contributing to a favorable outcome. For example, one reason the fight for the Gold Wall turned out to be so lopsidedly decisive was that U.S. forces had tanks, and JAM did not. The reader can surely think of other examples. Understanding why the battle turned out as it did is important to assessing its implications for the future Army. The next chapter derives those implications.

## Reimagining Urban Combat

---

The urban environment supposedly conveys marked advantages to the defender. Buildings and streets canalize maneuver, provide cover, conceal forces and maneuver, and constitute ready-made fortifications. For the insurgent, these advantages can compensate for the superior numbers and technology available to government forces and their international allies. Moreover, the collateral damage attendant to urban assaults can erode the government's legitimacy and even mobilize further opposition to it.

The Battle of Sadr City illustrates another way to think about urban combat in the context of irregular warfare. In this battle, U.S. forces did not allow themselves to get tied down in intense combat on unfamiliar terrain. Instead, 3-4 BCT was able to contain the enemy to a limited space and then neutralize his offensive capability with precision and restraint. Victory still required hard fighting, but it did not require turning Sadr City into rubble like the November 2004 Battle of Fallujah or Aachen in World War II.

Like the aforementioned battles, the Battle of Sadr City took place in a distinct time and place under a relatively unique set of conditions. These contextual elements do not prevent generalization, but they should temper it. Had JAM been just a little bit more competent, securing Ishbilyah and Habbibiyah might have required more forces. Had the Iraqi security forces been only recently organized, it is doubtful that they could have stood up to JAM with any amount of U.S. support. In the final analysis, however, we think these contextual factors are not entirely random. Irregular and even hybrid opponents will have vulnerabilities as well as strengths. The insights we list below implicitly reflect our weighting of such contingent factors, but the reader is advised to consider them as well.

In this chapter we describe the important insights emerging from our analysis of the battle. We believe those insights have important implications for future Army force development. The chapter concludes by positing a different way of thinking about urban combat.

## Key Insights from the Fight

The defeat of JAM in Sadr City during the six weeks of high-intensity operations yields several insights. Those insights should inform future Army force development. We record them in the sections below.

### **Protecting the Population Requires a Balance Between Offensive, Defensive, and Stability Operations**

Counterinsurgency doctrine accords tremendous importance to protecting the population. Some analysts posit a tension between this end and offensive combat operations. The surge, the Baghdad Security Plan, and the 2008 Battle of Sadr City indicate that this tension might be more apparent than real. In Sadr City, JAM was the source of insecurity. As we detailed in Chapter Three, JAM's conduct was causing the population under its control to become somewhat restive. As long as JAM maintained a monopoly of violence in Sadr City, however, the population would continue to render tangible, if reluctant, support. JAM managed to intimidate or corrupt Iraqi security forces sent to confront them. Providing security to Sadr City's population was not possible until JAM was defeated. After JAM's defeat, the Iraqi Army's 44th Brigade was able to extend government control throughout Sadr City. U.S. and Iraqi forces exploited their victory to further disrupt and dismantle insurgent networks in the meantime.

### **Persistent ISR, Technical Intelligence, and Precision-Strike Capabilities Enable the Attacker to Seize the Initiative**

Persistent ISR, technical intelligence, and responsive precision-strike capabilities (afforded by attack helicopters, fixed-wing CAS, UASs, and GMLRS) were fundamental to success and must be integrated. To be absolutely clear, coalition forces could not have achieved the same results at the same cost without these capabilities. Political constraints, described in Chapter Two, precluded U.S. ground maneuver operations beyond Route Gold. More importantly, the demands of combat in Ishbilyyah and Habbibiyah to seize the rocket sites indicate that even if the al-Maliki government had relaxed its ban on U.S. ground operations north of Gold, such operations would have required a lot more forces. MNF-I would have been forced to reallocate maneuver forces from other priority efforts, which was precisely the effect that JAM was trying to achieve. Aerial strike and ISR did not win the battle by themselves, but 3-4 BCT could not have won the battle without them.

Integrating airborne ISR and precision-strike assets into ground operations in urban environments presents significant airspace command and control challenges. Multiple aerial platforms and means of direct and indirect fire are being employed in a relatively small area of operations. Air traffic controllers and fire support coordinators require training in this complicated and important context. At the time, the level of support 3-4 BCT received was unprecedented.

The Army has recognized the importance of increasing its organic ability to provide sustained aerial ISR to unit commanders and is taking steps to meet those needs. The Army is already taking steps to augment its airborne ISR and precision-strike capabilities. Army combat aviation brigades now include 12 MQ-1C “Gray Eagle” extended-range multipurpose unmanned aerial systems.<sup>1</sup> The Gray Eagles are the equivalent of the armed Predator employed in this battle.

Nonetheless, these assets are key in showing proportionality and deliberateness, in attacking targets “among the people” with low collateral damage, and in reducing soldier exposure to the risks of urban combat. MND-B’s public affairs officer and its information operations officer believed that their ability to demonstrate this level of precision and proportionality using actual video footage helped avert or contain public anger.

Finally, relatively large guided bombs (500 pounds or larger) released from fixed-wing aircraft are needed to destroy some categories of urban targets (e.g., multistory buildings). This need occurred relatively rarely during the battle, but was important when it did. In particular, snipers in one five-story building overlooking Route Gold significantly slowed progress on the wall, while the structure itself seemed to provide adequate cover and concealment from the BCT’s organic weapons. After several days, units were finally authorized use of a Joint Direct Attack Munition to demolish the building.

### **Technical Capabilities Must Enable Decentralized Decision Making and Small Unit Initiative**

The enemy is fleeting, which means that decentralized decision making is required. Units at the brigade level and below must therefore have access to the information and other capabilities required to support the rapid decisions necessary to deal with a highly mobile enemy (who understands his own vulnerabilities) and to enable effective, independent action. Some gaps remain in getting “ISR to the objective.” As we noted in Chapters Two and Four, companies and possibly platoons require access to SIPRnet traffic but have a hard time getting it. Current operations have yet to truly stress extant capabilities in a dynamic environment. Platoon leaders and subordinate element leaders still had to rely on voice descriptions of the objectives and activities taking place there during raids conducted before and after the battle. They had to depend on the battalion tactical operations center or tactical command post to interpret video feeds for them.

---

<sup>1</sup> Project Manager, Unmanned Aerial Systems Project Office, Program Manager “MQ-1C Gray Eagle Unmanned Aircraft Systems,” March 14, 2012.

### **Isolating the Enemy Enables the Counterinsurgent to Seize the Initiative**

The guerilla or insurgent depends on mobility. Mao's aphorisms frequently refer to the importance of mobility, directing the guerilla to withdraw when the enemy is stronger, or noting that the population is the "sea" through which the guerilla fish "swims." Mobility and concealment allow the insurgent to counter the state's advantages in material and mass by striking vulnerable points at a time of the insurgent's choosing. As long as the insurgent retains the initiative, it can be said that as long as he is not losing, he is winning.

Isolating areas of operation deprives the insurgent of his advantages of mobility and concealment. Even before the Battle of Sadr City, 2-82 BCT's operations during the surge deprived al-Qaeda in Iraq the ability to inflict mass casualties and fuel the burgeoning civil war. 2-82 BCT's primary tool in this effort was the concrete T-wall. Attempting to cross these barriers only made insurgent leaders visible. If they tried to hide, it was just a matter of time before coalition forces located them and killed or captured them. These tactics contained, and then neutralized, the Sunni insurgency. Before the battle, they also disrupted JAM's leadership structure. Finally, in cutting JAM off from its lifeline in the Jamiliyah Market, the Gold Wall forced the enemy to fight or wither on the vine. Concrete enlisted time on the side of the counterinsurgent.

### **Ground Maneuver Remains Indispensable for Shaping the Battle and Achieving Decision**

We have already noted that 3-4 BCT and MND-B could not have achieved the same favorable outcome at a similar cost without heavy reliance on aerial ISR and strike. Ground maneuver was equally essential to coalition success in the Battle of Sadr City. Aerial ISR and strike were successful because they only had to control a portion of the area of operations, the area within 107mm rocket range of the Green Zone but beyond Route Gold. Superiority in ground maneuver not only enabled the BCT to seize the launch sites in Ishbilyah and Habbibiyah, but was also essential in enabling 3-4 BCT to seize control of the fight from JAM. Finally, we should note that it was the ground maneuver fighting along the wall that largely destroyed JAM's military capability.

Building the wall along Route Gold was an integral part of ground maneuver. It severely restricted the enemy's ability to employ indirect fire; forced enemy fighters to respond to the increasing isolation that the Gold Wall, if finished, would cause; and separated the adversary from the population.

### **Heavy Armored Forces Have Enduring Utility in Counterinsurgency and Urban Operations**

Armored forces—i.e., tanks and infantry fighting vehicles—are key elements of maneuver in complex terrain. In the Battle of Sadr City, armored forces included Abrams tanks, Bradley Fighting Vehicles, and Stryker armored vehicles. Each system had its advantages and disadvantages, and each complemented the others. Initially, 1-2 SCR suffered heavily from EFPs and other anti-armor systems, and found itself

struggling harder to attain tactical overmatch in intense combat. Augmenting its force with tanks and Bradley Fighting Vehicles provided that degree of tactical overmatch, as demonstrated by B/1-2 SCR's battle to seize NAI 608. On the other hand, the tanks and Bradleys needed overwatch and security from the dismounted infantry the Strykers carried. Armored combat vehicles are survivable, lethal, and precise. Additionally, and perhaps somewhat counterintuitively, they often cause less collateral damage than an artillery or CAS strike. The protection provided by their armor allows soldiers to be careful and precise about selecting and engaging their target.

### **Integrating SOF into Conventional Operations Achieves Synergy**

Conventional forces benefited significantly from SOF actions before, during, and after the battle. Special operations forces provide unique capabilities to exploit intelligence to kill or capture insurgent leaders. As we have observed, JAM actions during the battle were frequently ill-conceived and ill-coordinated, contributing to the speed and thoroughness of coalition success.

### **Snipers Remain an Important Enabler in Urban Operations**

Snipers are important assets in urban operations. They are key assets, particularly in countersniper operations and for intelligence collection. In the battle of Sadr City, SOF snipers played critical roles suppressing enemy snipers during the construction of the Gold Wall. Conventional snipers at the battalion and company levels played a similar role in providing overwatch to company operations. As TF 1-6 IN found, they were also extremely useful in a passive surveillance role. We should also mention the important role snipers played in training the BCT's route clearance company. The engineers found the training they had received from snipers in scanning for anomalies to be by far the most useful capability they had to detect IEDs and EFPs.

### **Enduring Success Depends on Capable Indigenous Security Forces**

The ultimate success of the operation depended on capable Iraqi security forces. If the 44th Brigade had not been capable of securing Sadr City north of Route Gold, JAM could simply have reconstituted in this sanctuary and resumed its belligerent behavior in a few months.

Developing capable indigenous forces takes time; 3-4 BCT was fortunate that years of U.S. efforts in this arena were beginning to bear fruit. For example, several of the more successful junior leaders during the 44th Brigade's attack to Route Gold were graduates of the Iraqi military academy. It also took time for aggressive, aware leaders like General X to emerge. Likewise, without the experience of managing a "checkpoint army," it seems doubtful that the Iraqis could have moved on to the more challenging task of offensive operations. Capable indigenous security forces are indispensable for securing gains. In the case of Iraqi security forces, it took some time for them to



develop competence. Until they did, coalition forces had to both train them and shoulder the bulk of the security challenges.

### **Urban Counterinsurgency Requires Forces to Transition Rapidly Between Offensive, Defensive, and Stability Operations**

A force capable of rapid transitions is important. Soldiers in 3-4 BCT were executing population-centric counterinsurgency before the battle of Sadr City. They rapidly transitioned into conducting high-intensity, decentralized, close combat operations. The most time-consuming part of the transition was TF 1-68's retrieval of its tanks and Bradley Fighting Vehicles from the U.S. base at Taji. Its pre-deployment training activities, which had emphasized traditional combat operations, probably helped in this transition. That emphasis is not necessarily a template for the future, since it implicitly depended on the experience unit leaders had already acquired in counterinsurgency in Iraq. After al-Sadr declared a truce on May 12, 2008, U.S. forces again shifted their emphasis to counterinsurgency and stability operations. What we can say is that leaders must understand the likelihood of such transitions and balance their preparations accordingly.

### **Reimagining Urban Operations as Wide-Area Security Missions**

Two general models for dealing with insurgent control of urban areas have become apparent in recent years. The first is the approach taken by the Russian Federation in the Chechen city of Grozny in December 1999–February 2000 and by U.S. forces in the Iraqi city of Fallujah in November 2004. Insurgents in these cities were viewed as cancers that had to be excised. In both of these cases, the cities were essentially besieged and then stormed, a course of action made possible by their geographic isolation. Non-combatants were told to leave before military operations within the cities commenced. Anyone who remained was, in general, viewed as a combatant in what became a block-by-block clearing operation supported by massive amounts of firepower.

Not surprisingly, both cities suffered significant damage. Indeed, their post-combat states remind one of a remark attributed to a U.S. Army major during the Vietnam War: “It became necessary to destroy the town to save it.”<sup>2</sup> Figure 8.1 indicates the damage suffered by Fallujah during the November 2004 battle.

Additionally, casualties among Russian and U.S. forces were high. Although reliable figures are difficult to ascertain, the Russian Federation suffered at least 600 dead (mostly in Grozny, it is assumed) and likely many more wounded in Chechnya

---

<sup>2</sup> “Major Describes Move,” *The New York Times*, February 8, 1968. The short column goes on to put the major's remark in context as to why the village of B n Tre was attacked: “He was talking about the decision by allied commanders to bomb and shell the town regardless of civilian casualties to rout the Vietcong.”

**Figure 8.1**  
**Fallujah After the Defeat of Insurgents by U.S. Forces**



SOURCE: U.S. Navy.  
 RAND RR160-8.1

between December and early January.<sup>3</sup> In Fallujah, U.S. forces suffered 70 dead and more than 600 wounded.<sup>4</sup> Thus, this model of urban warfare anticipates and accepts extensive collateral damage and relatively high numbers of friendly casualties.

The 2008 Battle of Sadr City offers a second model for wresting control of a city from insurgents: treating an urban area as a wide-area security mission. In Sadr City, unlike in Grozny and Fallujah, telling the civilians to leave what was about to become a high-intensity battlefield simply was not feasible. Sadr City had 2.4 million residents, and there was nowhere for them to go: Sadr City is part of the larger city of Baghdad and, unlike Grozny and Fallujah, is not geographically isolated. These conditions in Sadr City may be representative of the future challenges of urban operations, and they will likely worsen as urban areas around the globe become larger and more densely populated. The objective was not to take and clear Sadr City but to create conditions that would make it both impossible for the insurgents to operate effectively and possible to restore security to the broader population.

<sup>3</sup> Olga Olikier, *Russia's Chechen Wars 1994–2000: Lessons from Urban Combat*, Santa Monica, Calif.: RAND Corporation, MR-1289-A, 2001, pp. 49–50.

<sup>4</sup> Matt M. Matthews, *Operation AL FAJR: A Study in Army and Marine Corps Joint Operations*, Global War on Terrorism Occasional Paper 20, Fort Leavenworth, Kan.: Combat Studies Institute Press, p. 77.

Thus, in the Battle of Sadr City, the focus was on enemy fighters and their capabilities. U.S. forces deprived the enemy of the ability to affect events at the operational and strategic levels of war. JAM's control of Sadr City was a perennial problem, but what made its March 2008 offensive problematic was JAM's ability to strike the Green Zone with indirect fires (mainly via rockets). As one U.S. Army officer noted:

What I find fascinating about Sadr City is that in 2005 it was held up as an example of effective COIN; how focusing on economic development and essential services were more effective tools for lowering violence than lethal ops. But when my unit arrived at FOB Loyalty in late 2007 almost all of the attacks against us originated from that enemy safe haven. It wasn't until we kicked the enemy's ass on his own turf that the tide turned. We poured all manner of projects into that place between 2004–2007 but all we had to show for it were EFPs, IRAMs and casualties. An effective lethal operation with a fraction of our combat power did in two months what 100s of millions [of dollars] spent over several years could not. Yet we never really bothered to learn that lesson.<sup>5</sup>

Attacks on the Green Zone threatened to derail the Basra offensive and thereby reveal that the al-Maliki government was fatally ineffective. However, 3-4 BCT took JAM's offensive capability away by employing determined ground maneuver, which combined infantry and armored vehicles, with support from pervasive ISR and precision-strike capabilities, which were provided by UASs, attack helicopters, artillery, and CAS. Without its indirect-fire capability, JAM could only react locally as coalition forces exploited human and technical intelligence to hunt down its remaining leaders under extremely one-sided conditions.

## Final Thoughts

Sadr City demonstrates that one of the keys to fighting an urban adversary is to create a situation that will force the enemy to surrender the advantages of the city. This is not dissimilar to the advice given by Sir Julian S. Corbett in his classic treatise *Some Principles of Maritime Strategy*, published in 1911:

In applying the maxim of “seeking out the enemy's fleet” it should be borne in mind:

1. That if you seek it out with a superior force you will probably find it in a place where you cannot destroy it except at heavy cost.

---

<sup>5</sup> Email from Colonel Craig A. Collier to David E. Johnson, June 6, 2011. Colonel Collier commanded 3rd Squadron, 89th Cavalry Regiment, 4th Brigade, 10th Mountain Division at FOB Loyalty in Iraq from 2007 to 2008.

2. That seeing that the defensive is a stronger form of war than the offensive, it is prima facie better strategy to make the enemy come to you than to go to him and seek a decision on his own ground.<sup>6</sup>

Corbett's advice about creating conditions that "make the enemy come to you" is what happened in the 2008 Battle of Sadr City when 3-4 BCT began building the Gold Wall that JAM had to contest. This is the art of reimagining urban warfare, and it clearly has doctrinal, organizational, materiel, leader development, and training implications for both the U.S. Army and the joint force. In case of the 2008 Battle of Sadr City, building the wall along Route Gold threatened to deny JAM access to key terrain and, as Colonel Hort related during an interview with the authors, "agitated the enemy." Quite simply, JAM had to contest the wall or face isolation. In the words of another U.S. officer, the wall was the equivalent of a Roman siege engine about to breach a city's defenses. It created a situation that was intolerable to JAM, and JAM had to come out and fight. In so doing, the enemy attacked U.S. forces that now had the initiative and were in a position of enormous advantage. JAM lost, and the coalition victory in the Battle of Sadr City offers important lessons for the prosecution of future urban operations.

---

<sup>6</sup> Julian S. Corbett, *Some Principles of Maritime Strategy*, London: Longmans, Green, and Co., 1911; reprint, with introduction and notes by Eric J. Grove, Annapolis: United States Naval Institute Press, 1988, pp. 324–325.



## Analysis of Contemporary Arabic Language Sources on the Battle of Sadr City

---

Contemporary Arabic language news and Internet sources have relatively little to say about the 2008 Battle of Sadr City. Those the research team was able to find tend to support the inference that the Sadrist movement consciously linked operations in Sadr City with those in Basra. Those sources also indicate that Shia militia leaders found coalition forces' construction of the wall to be highly provocative. Contemporary sources do not provide a coherent counternarrative describing the battle and explaining its outcome.

For instance, a number of websites carry the name of the Sadrist offensive as "Sawlat Al al-Sadr," or Operation Charge of the Companions of al-Sadr.<sup>1</sup> Sadrist websites framed the offensive as a defensive "reaction" against the Iraqi government's operation, lumping together operations against Iraqi and U.S. armed forces across the country, from Baghdad to Basra. The Sadrist offensive's name was apparently intended as a response to the name of the Iraqi Army's operation, "Sawlat al-Fursan," or Operation Charge of the Knights. Some of these sites hosted Arabic-language "battle hymns" and logs of attacks by JAM and the affiliated League of the People of Truth [*'Asa'ib Ahl al-Haq*] against Iraqi and American forces.<sup>2</sup>

In an article from the London-based Arabic daily *Asharq Al-Awsat*, a journalist reported on events and local reactions as American forces drew closer to completing the wall. Iraqi troops reportedly entered the city peacefully and teamed up with JAM "representatives" to clear the streets of approximately 50 IEDs and strands of detonation cord.<sup>3</sup> A spokesman for the al-Sadr Martyrs Office expressed "annoyance" that

---

<sup>1</sup> Al-Roafd Internet Forums, "Akhbar Jaysh al-Imam al-Mahdi ('aj) fi Sawlat Al al-Sadr [News of the Imam al-Mahdi Army in Charge of the Companions of al-Sadr]," posted August 16, 2010. (Attacks ranged between May 8, 2008, and July 2, 2008.)

<sup>2</sup> Al-Moqawamon Internet Forums, "3 `amaliyat li `asaab ahl al-haq (sawlat aal al-sadr) [3 Operations by the League of the People of Truth (Charge of the Companions of al-Sadr)]," posted April 28, 2010.

<sup>3</sup> Hadi Jassim, "Al-Qawat al-'Iraqiyya Tadhkhal Medinat al-Sadr . . . wa al-Ahali Munqasimun bayn al-Farah wa al-Khawf" [The Iraqi Forces Enter Sadr City . . . and the People Are Divided Between Joy and Fear], *Asharq*

the wall would cut Sadr City off from the rest of Baghdad, and warned that the construction of the wall would “necessarily” lead to a new crisis.<sup>4</sup> A municipal official not affiliated with al-Sadr also complained that the wall would isolate the city economically. Residents, who were also opposed to the barrier’s construction, reportedly used a number of disparaging names for what American forces called the Gold Wall, including the Berlin Wall, the Black Wall, and the Wall of Poverty.<sup>5</sup>

Some Iraqis portrayed al-Maliki’s operations in Sadr City not only as criminal but also as reminiscent of a similar siege of Sadr City led by Qusay Hussein during the 1991 Shiite uprisings.<sup>6</sup> “This time,” one forum participant wrote in early April 2008, remarking on how eerily similar the two sieges were, “history repeats itself as if it were a cartoon.”<sup>7</sup> He pointed out the irony that al-Maliki had decried the 1991 siege of Sadr City from exile in Damascus, but now was repeating the offensive and even using the same justifications, vocabulary, and methods. Other Iraqis apparently doubted al-Maliki’s claim that the Charge of the Knights operations were intended to clean Sadr City of criminals and smugglers. In the same forum thread, one particularly sarcastic Iraqi forum participant, while acknowledging that al-Maliki was right to go after oil smugglers and thieves in Basra, asked, “[But] what is he targeting in Sadr City and Kadhimiya? Papyrus smugglers?” The writer claimed that Sadr City was actually safer thanks to “the [so-called] outlaws,” meaning the Sadrists and their Shiite allies. Another commentator asserted that the Sadr City offensive was designed to cover al-Maliki’s “defeat” in Basra.<sup>8</sup>

Moqtada al-Sadr released an official statement on April 18, 2008 decrying the siege. He cited some 398 deaths, 1,331 injuries, and 98 houses destroyed in addition to the burning of many stores, shops, and cars, adding that the city’s psychological, health, and economic situation, in addition to its public services, had severely deteriorated due to the military operations.<sup>9</sup> He complained specifically about the American occupation of Sadr City’s education headquarters and demanded, among other things, the immediate removal of barriers that were “beginning to cut off Sadr City.”<sup>10</sup>

---

*al-Awsat*, May 18, 2008.

<sup>4</sup> Hadi Jassim.

<sup>5</sup> Hadi Jassim.

<sup>6</sup> Iraqi Forum, “Qawat al-Mujrim al-Maliki. Tuhasir Medinat al-Sadr!! [Maliki’s Criminal Forces Lay Siege to Sadr City],” Iraqi Forums, April 2, 2008.

<sup>7</sup> Iraqi Forum, April 2, 2008.

<sup>8</sup> Iraqi Forum, April 2, 2008.

<sup>9</sup> Iraqi Forum, “Qawat al-Mujrim al-Maliki. Tuhasir Medinat al-Sadr!! [Maliki’s Criminal Forces Lay Siege to Sadr City],” Iraqi Forums, April 18, 2008.

<sup>10</sup> Iraqi Forum, April 18, 2008.

## Bibliography

---

Al-Moqawamon Internet forums, “3 `amaliyat li `asaib ahl al-haq (sawlat aal al-Sadr) [3 Operations by the League of the People of Truth (Charge of the Companions of al-Sadr)],” posted April 28, 2010. As of April 11, 2011:

<http://moqawomon.com/showthread.php?t=2205>

Al-Roafd Internet Forums, “Akhbar Jaysh al-Imam al-Mahdi (`aj) fi Sawlat Al al-Sadr [News of the Imam al-Mahdi Army in Charge of the Companions of al-Sadr],” posted August 16, 2010 (attacks range between May 8, 2008 and July 2, 2008). As of April 11, 2011:

<http://www.roafd.info/vb/showthread.php?t=4759>

Al-Shahery, Omar, written responses to questions, June 4, 2010.

“A U.S. Combat Brigade Commander Was Shot by a Sniper While Surveying the Construction of a Wall to Protect a Sunni Arab Enclave in Baghdad, the U.S. Military Said on Monday,” *Reuters*, May 7, 2007. As of June 6, 2011:

<http://www.reuters.com/article/2007/05/07/us-iraq-commander-idUSIBO76363420070507>

Ballagh, Lieutenant Colonel Robert S., interview with M. Wade Markel, the Pentagon, February 8, 2011.

Boyle, Michael, “What Moqtada al-Sadr’s Return Means,” *The Guardian*, January 11, 2011. As of June 16, 2011:

<http://www.guardian.co.uk/commentisfree/cifamerica/2011/jan/11/iraq-iran>

Bradford, Major Jonathan, interview with M. Wade Markel, the Pentagon, July 9, 2010.

Cave, Damien, et al., “Assessing the ‘Surge’: A Survey of Baghdad Neighborhoods,” *The New York Times*, September 6, 2007. As of March 2013:

[http://www.nytimes.com/interactive/2007/09/06/world/middleeast/20070907\\_BUILDUP\\_DETAIL\\_GRAPHIC.html?neighborhood=sadrcity](http://www.nytimes.com/interactive/2007/09/06/world/middleeast/20070907_BUILDUP_DETAIL_GRAPHIC.html?neighborhood=sadrcity)

Chiarelli, Peter, and Patrick Michaelis, “Winning the Peace: The Requirement for Full-Spectrum Operations,” *Military Review*, July/August 2005, pp. 4–14.

Cochrane, Marisa, *Special Groups Regenerate: Summer 2007–Summer 2008*, Washington, D.C.: Institute for the Study of War, 2008.

Cockburn, Patrick, *Moqtada al-Sadr and the Battle for the Future of Iraq*, New York: Simon and Schuster, 2008.

Colby, John, *War from the Ground Up: The 90th Division in WWII*, Austin, Tex.: Nortex Press, 1991.

Collier, Colonel Craig, “Two Cheers for Lethal Operations,” *Armed Forces Journal International*, August 2010.



Corbett, Julian S., *Some Principles of Maritime Strategy*, London: Longmans, Green, and Co., 1911; reprint, with introduction and notes by Eric J. Grove, Annapolis: United States Naval Institute Press, 1988.

Cordesman, Anthony, and Samantha Lomeli, *Iraqi Force Development: A Progress Report*, Washington, D.C.: Center for Strategic and International Studies, 2007.

Dawisha, Adeed, "Iraq: A Vote Against Sectarianism," *Journal of Democracy*, Vol. 21, No. 3, July 2010, pp. 26–40.

Defense Industry Daily, "The USA's RAID Program: Small Systems, Big Surveillance Time," August 24, 2011. As of March 11, 2012: <http://www.defenseindustrydaily.com/the-usas-raid-program-small-aerostats-big-surveillance-time-02779/>

DiGiambattista, Lieutenant Colonel John, interview with M. Wade Markel and Brian Shannon, Fort Carson, Colorado, January 12, 2010.

Downing, Major Will, interview with M. Wade Markel and Brian Shannon, Fort Carson, Colorado, January 12, 2010.

Eifler, Lieutenant Colonel Brian, telephone interview with M. Wade Markel, April 26, 2010.

Enders, David, "Behind the Wall: Inside Baghdad's Sadr City," *Virginia Quarterly Review*, Vol. 85, No. 3, Summer 2009, pp. 120–135.

Farris, Brigadier General Billy Don, II, interview with David E. Johnson, M. Wade Markel, and Brian Shannon, the Pentagon, March 18, 2010.

Farris, Billy Don, II, "Warfighter Observations During the Surge: 2nd Brigade Combat Team, 82nd Airborne Division, "Task Force Falcon,"" briefing, c. 2008.

Freeman, Sholnn, and Sudarsan Raghavan, "Sadr Tells His Militia to Cease Hostilities; Cleric, in Return, Wants Followers' Release, Amnesty," *The Washington Post*, March 30, 2008, p. A1.

Gibby, Major Bryan, telephone interview with M. Wade Markel, January 27, 2010.

Gordon, Michael, "In Spite of Truce, War of Attrition over Wall Persists in Sadr City," *The New York Times*, May 15, 2008, p. A6.

Gordon, Michael R., and Bernard E. Trainor, *The Endgame: The Inside Story of the Struggle for Iraq, from George W. Bush to Barack Obama*, New York: Pantheon Books, 2012.

Graham, Lieutenant Colonel Barry, interview with M. Wade Markel, the Pentagon, January 19, 2010.

Grimsley, Major General William F., video teleconference with David E. Johnson, M. Wade Markel, and Brian Shannon, May 26, 2010.

Hammond, Major General Jeffery, interview with David E. Johnson and M. Wade Markel, Fort McPherson, Georgia, February 25, 2010.

Headquarters, 3rd Brigade, 4th Infantry Division, "Operation Iraqi Freedom: December 2007–March 2009," briefing, April 2009.

Headquarters, TF 1-68 AR, *TF 1-68 History: Operation Lion Firestorm*, undated.

Hort, Colonel John, interview with David E. Johnson and M. Wade Markel, November 5, 2010.

Hughes, Geraint, "The Insurgencies in Iraq, 2003–2009: Origins, Developments and Prospects," *Defence Studies*, Vol. 10, No. 1, May 2010, pp. 152–176.

International Crisis Group, *Iraq's Civil War, the Sadrists and the Surge*, Middle East Report No. 72, February 7, 2008.

- Iraqi Forum, "Qawat al-Mujrim al-Maliki . . . Tuhasir Medinat al-Sadr!! [Maliki's Criminal Forces Lay Siege to Sadr City]," Iraqi Forum, April 2, 2008. As of April 8, 2011:  
<http://www.iraqiforum.net/vb/1207.html>
- "Iraq's Basra Police Chief Says Plan Drawn Up to Eliminate Militias," British Broadcasting Service, March 15, 2008.
- Jassim, Hadi, "Al-Qawat al-'Iraqiyya Tadhkhal Medinat al-Sadr . . . wa al-Ahali Munqasimun bayn al-Farah wa al-Khawf" [The Iraqi Forces Enter Sadr City . . . and the People Are Divided Between Joy and Fear], *Asharq al-Awsat*, May 18, 2008. As of April 8, 2011:  
<http://aawsat.com/details.asp?section=4&article=471139&issueno=1076>
- Jones, James L., *Report of the Independent Commission on the Security Forces of Iraq*, September 6, 2007.
- Kagan, Kimberly, "Enforcing the Law: The Baghdad Security Plan Begins," *The Weekly Standard*, February 10, 2007–March 5, 2007.
- Keller, Lieutenant Colonel Chris, interview with M. Wade Markel, Arlington, Virginia, August 4, 2010.
- Leland, John, "Baghdad's Shiite Heart Beats Freely as War Ebbs," *The New York Times*, October 30, 2010, p. A1.
- Lewis, Command Sergeant Major Steve, telephone interview with M. Wade Markel, July 28, 2010.
- Long, Austin, *Doctrine of Eternal Recurrence: The U.S. Military and Counterinsurgency Doctrine, 1960–1970 and 2003–2006*, Santa Monica, Calif.: RAND Corporation, OP-200-OSD, 2008. As of November 14, 2013:  
[http://www.rand.org/pubs/occasional\\_papers/OP200.html](http://www.rand.org/pubs/occasional_papers/OP200.html)
- Looney, Major Todd, telephone interview with M. Wade Markel and Brian Shannon, April 29, 2010.
- Ludwig, Konrad R. K., *Stryker: The Siege of Sadr City*, Roland-Kjos Publishing, 2013.
- Matthews, Matt M., *Operation AL FAJR: A Study in Army and Marine Corps Joint Operations*, Global War on Terrorism Occasional Paper 20, Fort Leavenworth, Kan.: Combat Studies Institute Press.
- Messmer, Lieutenant Colonel Gerry, telephone interview with M. Wade Markel, April 26, 2010.
- Messmer, Lieutenant Colonel Gerry, telephone interview with M. Wade Markel, November 9, 2010.
- Mohammed, Wisam, and Ahmed Rasheed, "Truce Call Catches Militants Off Guard; Iraqi Shiite Cleric Urges Fighters to Stop Battling Government Forces," *The Toronto Star*, March 31, 2008, p. AA01.
- Morse, Captain Kyle, telephone interview with M. Wade Markel, July 6, 2010.
- North, Major Brian, interview with M. Wade Markel and Brian Shannon, Fort Carson, Colorado, January 12, 2010.
- Northrop, Major Jason, written response to questionnaire, August 14, 2010.
- Northrop, Major Jason, interview with David E. Johnson and M. Wade Markel, Arlington, Virginia, March 16, 2011.
- Oliker, Olga, *Russia's Chechen Wars 1994–2000: Lessons from Urban Combat*, Santa Monica, Calif.: RAND Corporation, MR-1289-A, 2001. As of November 14, 2013:  
[http://www.rand.org/pubs/monograph\\_reports/MR1289.html](http://www.rand.org/pubs/monograph_reports/MR1289.html)
- Paley, Amit R., "U.S. Deploys a Purpose-Driven Distinction; Reluctance to Identify Foes as Sadrists Reflects View of Iran and Fragility of Security Gains," *The Washington Post*, May 21, 2008, p. A8.

Pappal, Colonel Mike, telephone interview with David E. Johnson, M. Wade Markel, and Brian Shannon, July 2, 2010.

Pemrick, Lieutenant Colonel Mike, interview with M. Wade Markel, Fort Belvoir, Virginia, February 26, 2010.

Petraeus, David H., "CENTCOM Update," briefing presented at the Center for a New American Security, Washington, D.C., June 11, 2009.

Project Manager, Unmanned Aerial Systems Project Office, Program Manager "MQ-1C Gray Eagle Unmanned Aircraft Systems," March 14, 2012.

Raghavan, Sudarsan, "19 Tense Hours in Sadr City Alongside the Mahdi Army; After Calm Year, Fighting Engulfs Shiite Enclave," *The Washington Post*, March 29, 2008, p. A1.

Rainey, Colonel Jim, interview with M. Wade Markel and Brian Shannon, Fort Carson, Colorado, January 11, 2010.

Rausch, Captain Clint, telephone interview with David E. Johnson and M. Wade Markel, September 23, 2010.

Ries, Marcie, interview with M. Wade Markel, Washington, D.C., May 7, 2010.

Rubin, Alissa J., and Mudhafer al-Husaini, "Baghdad Blast Kills Four Americans," *The New York Times*, June 25, 2008. As of January 10, 2011:  
<http://www.nytimes.com/2008/06/25/world/middleeast/25iraq.html>

Sengupta, Kim, "The Final Battle for Basra Is Near, Says Iraqi General," *The Independent*, March 20, 2008.

Serwer, Daniel, and Sam Parker, *USIP Briefing: Maliki's Iraq Between Two Elections*, Washington, D.C.: United States Institute of Peace, May 2009.

Stover, Lieutenant Colonel Steve, interview with M. Wade Markel, Fort Meade, Maryland, April 23, 2010.

Talley, Major General Jeffrey, interview with M. Wade Markel and David E. Johnson, Dallas, Texas, June 2, 2010.

Thomas, Major Gina, telephone interview with M. Wade Markel, February 24, 2010.

Thompson, Lieutenant Colonel Kurt, telephone interview with M. Wade Markel, January 6–7, 2011.

Ucko, David H., *The New Counterinsurgency Era: Transforming the U.S. Military for Modern Wars*, Washington, D.C., Georgetown University Press, 2009.

United Nations, High Commissioner for Refugees (UNHCR), Iraq Operation, Monthly Statistical Update on Return, January 2011. As of February 28, 2011:  
[http://www.japuiraq.org/documents/1289/3\\_C%20December%202010%20Return%20Update%20IRAQ.pdf](http://www.japuiraq.org/documents/1289/3_C%20December%202010%20Return%20Update%20IRAQ.pdf)

United Nations, Inter-Agency Information and Analysis Unit, "Baghdad Governorate Profile," March 2009.

United Nations, Inter-Agency Information and Analysis Unit, "Baghdad Governorate Profile," February 2011.

United Nations, World Food Program, *Comprehensive Food Security and Vulnerability Analysis in Iraq*, Baghdad: World Food Program, 2008.

"US Links Iran to Attack in Iraq," *BBC News*, July 2, 2007. As of June 1, 2011:  
<http://news.bbc.co.uk/2/hi/6260690.stm>

Webster, Paul, "Reconstruction Efforts in Iraq Failing Health," *The Lancet*, Vol. 373, February 21, 2009, pp. 617–620.

Zimmerman, Lieutenant Colonel Frank, telephone interview with M. Wade Markel, March 5, 2010.



# Index

---

- 1st Calvary Division
  - as Multi-National Division–Baghdad, 3, 7
  - shaping effort by 2-82 BCT under, 4
- 1st Combined Arms Battalion, 68th Armored Regiment (TF 1-68 CAB)
  - and checkpoint attacks, 44–47
  - on eve of Battle, 29, 30
  - Hort’s augmentation of, 61
  - in initial concept of operations, 48
  - and Operation Gold Wall, 72–73
  - preparation of, 103
  - Sadr City night raids by, 36
  - training for, 31–32
  - transition out of OE Gold, 85
- 1st Division, Iraqi Army, 81
- 1st Squadron, 2nd Stryker Cavalry Regiment (1-2 SCR)
  - active patrol of launch sites, 58–60
  - armored vehicles for, 108–109
  - and checkpoint attack, 42–44
  - counterinsurgency operations by, 36
  - on eve of Battle, 29
  - in initial concept of operations, 48
  - and launch site control, 62–63
  - and Operation Gold Wall, 72–74
  - preparation of, 103
  - strikes against rocket attacks, 50, 51, 53
  - training for, 30, 31
  - transition out of OE Gold, 85
- 2nd Battalion, 42nd Brigade, Iraqi Army, 67–68
- 2nd Brigade Combat Team, 82nd Airborne Division (2-82 BCT), 3
  - in Baghdad after surge, 10–13
  - isolation of insurgents by, 108
  - isolation of Sadr City prior to battle, 13–14
  - shaping effort by, 4
  - during surge, 8–10
- 2nd Platoon, 1-2 SCR, 59–60
- 3rd Battalion, 42nd Iraqi Army Brigade, 64
- 3rd Brigade Combat Team, 4th Infantry Division (3-4 BCT)
  - aerial reconnaissance and strike assets of, 48–58
  - area of operations for, 31
  - in chain of command, 32
  - counterinsurgency following JAM’s defeat, 84
  - dispositions on March 15, 2008, 33
  - on eve of Battle, 29
  - Gold Wall built by, 3
  - ground maneuvers by, 112
  - heavy combat phase for, 4
  - in initial concept of operations, 48
  - initial engagement of, 39–40
  - insurgent leaders targeted by, 79
  - IRAM attack planning cell captured by, 89
  - and launch site control, 58, 59, 61, 62
  - medical engagements by, 91
  - as Multi-National Division–Baghdad, 3
  - in Operation Gold Wall, 71–78
  - reconstruction efforts of, 89–91
  - and Route Gold limit on advance, 47
  - standoff between JAM and, 35
  - strike assets of, 49–5
  - success of, 99–101
  - task organization, 32
  - technology resources management by, 2
  - training for, 30
  - turnover of operations to, 14
  - weapons employed by, 37
- 3rd Platoon, 1-2 SCR, 60
- 4th Brigade, 10th Mountain Division (4-10 BCT)

- and air weapons support, 49, 50
- and JAM's initial attack, 51
- wall-building by, 76, 77
- 9th Division, Iraqi Army, 81
- 42nd Brigade, Iraqi Army, 45–46
- 44th Brigade (Iraqi Army), 68
  - assessing capabilities of, 94
  - capability of, 109
  - and JAM's initial attack, 40, 41
  - police supplementing, 95
  - and seizure of Route Gold, 64
- 60 Minutes*, 2
- 237th Engineer Company, Virginia Army National Guard
  - checkpoint ambush of, 45
  - on securing Route Gold, 65–66
  - training for, 34
- 926th Engineer Brigade, Army Reserve
  - rebuilding by, 91–94
  - in reconstruction effort, 84
  - in reconstruction efforts, 3
- A Company, 1st Battalion, 21st Infantry Regiment (Stryker), 61
- active patrolling, launch site control through, 58–61
- aerial ISR and strikes
  - against rocket attacks, 48–58
  - and success of battle, 100
  - in urban combat, 107
- al-Maliki, Nouri
  - Basra offensive by, 17, 19, 47, 97
  - and Basra Sadrists, 18
  - Iraqis' portrayals of, 116
  - order to occupy Sadr City, 81
  - and political climate, 2
  - on restoring government control in Sadr City, 47
  - withdrawal of Sadrist Trend support for, 93
- al-Maliki government. *See* Iraqi government
- al-Qaeda in Iraq (AQI)
  - 2-82 BCT's defeat of, 10
  - and Baghdad Security Plan, 17
  - isolation of, 108
  - neutralization of, 17–18
- al-Sadr, Mohammed Sadiq, 26, 102
- al-Sadr, Moqtada, 23
  - Al-Maliki government support withdrawn by, 19
  - calls for cease-fire by, 3, 61, 62, 81, 102
  - on controlling militia elements, 24
  - failure to destabilize government, 97
  - and father's assassination, 26
  - fatwa* issued by, 93
  - and JAM's attack on Sadr City, 1
  - political calculations of, 2
  - second cease-fire announced by, 81
  - statement decrying siege by, 116
- al-Shahery, Omar, 29
- ambushes, near rocket launch sites, 59
- armored forces, in urban combat, 108–109
- Badr Corps, 93
- Baghdad
  - Baghdad Security Plan, 7–8, 17–18
  - conditions during surge, 8–9
  - Iraqi government's securing of, 65
  - number of attacks in (March 2007–February 2008), 18
  - post-surge control of, 8–13
  - State of Law candidates in, 99
- Baghdad Security Plan, 7–8
  - results of, 17–18
  - unfolding operations under, 8
- Ballagh, Rob, 76, 77
- Barnett, Dan
  - as 1-2 SCR commander, 29
  - and checkpoint attack, 43
  - on IEDs near launch sites, 60
  - on strikes against rocket attacks, 50, 51
  - on training, 34–35
- Basra offensive, 17, 19, 39, 47, 97
- Battle of Sadr City (March 2008), 1–4
  - assessing outcome of (*see* outcome assessment)
  - and Basra offensive, 17, 97
  - beginning of (*see* initial operations)
  - and building of Gold Wall (*see* Operation Gold Wall)
  - conditions preceding (*see* conditions on eve of Battle; conditions set for Battle)
  - exploitation phase of (*see* exploiting success)
  - importance of different aspects of, 3–4
  - insights from (*see* urban combat)
  - journalistic attention to, 1–2
  - and reconstruction effort, 3
- B Company, 1-2 SCR, 63
- B Company, 3rd Platoon, 1-2 SCR, 60
- Bradford, Jon
  - and checkpoint attack, 41–42
  - on Iraqi capabilities, 65
  - on JAM mortar fire, 26, 41
  - and launch site control, 60
  - on request for mine clearing line charge, 36–37

- and standoff between JAM and 3-4 BCT, 35
- brigade support battalion (BSB)
  - combat logistics patrols of, 36
  - manpower pressures on, 63–64
  - training for, 34
- “Brigadier General X”
  - and JAM’s initial offensive, 45
  - and securing of Route Gold, 64, 67–68
- Bush, George W., on surge, 7
- car bombs (VBIEDs), 10
- Casey, George, 35
- casualties
  - during Battle of Sadr City, 98
  - in Fallujah, 111
- C Company, 1-68 CAB
  - and checkpoint attacks, 44
  - and Operation Gold Wall, 72–73
  - training of, 37
- C Company, 1st Battalion, 27th Infantry Regiment, 61
- C Company, 1st Squadron, 2nd Stryker Cavalry Regiment (C/1-2 SCR), 27, 41
- C Company, TF 1-6 IN, 78
- cease-fire
  - first call for, 61, 62, 102
  - second call for, 81
- checkpoints
  - under Baghdad Security Plan, 8
  - and insurgents’ risk of capture, 11
  - JAM attack of, 40–43
- coalition forces, 1
  - under Baghdad Security Plan, 18
  - concrete walls used by, 7
  - reasons for success of, 99–103
- Cockburn, Patrick, 2, 81
- COIN Academy
  - challenge of training assumptions by, 35–37
  - preparation by, 103
- collateral damage
  - and COIN’s urge for restraint, 35–37
  - consequences of, 35
  - and population protection, 106
- Collins, Corey
  - and checkpoint ambush, 45
  - and EFP ambush, 38
  - and Route Bama, 81
  - on securing Route Gold, 65–66
  - on training, 34
- “Colonel Y,” 85–86
- Combined Joint Special Operations Task Force (CJOSTF), 85
- command and control, for 3-4 BCT, 53–54
- concrete barriers
  - under Baghdad Security Plan, 8
  - coalition forces’ use of, 7
  - to contain car bombs, 10
  - isolation of insurgents by, 108
  - Route Grizzlies wall, 86
  - See also* Gold Wall
- conditions on eve of Battle, 17–38
  - COIN Academy’s challenge of training assumptions, 35–37
  - context changes, 37–38
  - Iraqi security forces, 27–29
  - JAM, 23–27
  - physical and human terrain, 19–23
  - political and strategic context, 17–19
  - pre-deployment training, 30–35
  - U.S. forces, 29–30
- conditions set for Battle, 7–15
  - Baghdad Security Plan, 7–8
  - isolating Sadr City, 13–14
  - regaining control of Baghdad, 8–13
  - U.S. “surge” in Iraq, 7
- context of Battle
  - changes in, 37–38
  - political and strategic, 17–19
- COP Callahan, 86, 88
- Corbett, Sir Julian S., 112–113
- counterinsurgency
  - “day job” and “night job” in, 36
  - lessons learned for (*see* urban combat)
  - value of lethal force and reconstruction in, 2
- countersniper fight, 75
- Da’wa party, 93
- Dawisha, Adeed, 2
- D Company, 1-30 IN, 63
- D Company, 4th Battalion, 64th Armored (D/4-64 AR), 73
- D Company, TF 1-68 CAB, 61
- deaths
  - during Battle of Sadr City, 98
  - in Fallujah, 111
- decentralized decision making, 107
- DiGiambattista, John, 74
- displaced persons, 98
- Downing, Will
  - as battle major, 53
  - on cessation of Green Zone rocket attacks, 57
  - and securing of Route Gold, 67
  - on UAS feeds, 54



- economic development, 90
- Eifler, Brian  
 and medical engagements, 91  
 and microgrants distribution, 91  
 in Operation Gold Wall, 78  
 on snipers' contributions, 85  
 on training, 33–35  
 and transition to MRAPs, 89
- elections, 95–96, 98–99
- electricity problems, 92, 93
- Elgort, Kenneth, 60
- Endgame, The* (Gordon and Trainor), 2
- essential services, responsibility for, 93
- exploiting success, 83–96  
 and development of ISF, 94–95  
 by maintaining pressure, 85–89  
 and provincial elections, 95–96  
 through reconstruction, 89–94
- explosively formed penetrators (EFPs)  
 on borders of city, 86  
 Operation Gold Wall procedures for coping with, 73  
 persistence of, 95  
 on Route Bama, 81  
 traps using, 37–38
- explosive ordinance disposal (EOD) troops, 38
- Fadhil militias, 19
- Fallujah battle, 110–111
- Farris, Billy Don, II  
 on counterinsurgency, 36  
 methods used against Shia extremism, 12  
 on surge, 8–10  
 on VBIEDs, 10
- Fil, Joseph, Jr., 7
- “General M,” 95
- “General X,” 101, 109
- Gibby, Bryan, 24  
 on cessation of Green Zone rocket attacks, 57  
 on JAM fighting at Gold Wall, 78  
 and Operation Gold Wall, 74
- Gold Wall, 1  
 importance of, 3  
 Iraqi perspective on, 2, 115–116  
 purpose of, 3  
 success of, 101, 108  
*See also* Operation Gold Wall
- Gordon, Michael, 2
- Grafenwoehr, Germany, 78
- Graham, Barry, 23
- Gray Eagles, 107
- Green Zone attacks, 40, 41, 46, 57–58, 61, 112
- Grimsley, Will  
 and 1-2 SCR's launch site control capability, 62–63  
 on night raids into Sadr City, 36–37  
 and securing of Route Gold, 67
- ground maneuver/operations  
 integrating aerial ISR and strikes with, 106–107  
 in urban combat, 108, 112
- Grozny, Chechnya, 110–111
- Habbibiyah district, 20–22  
 controlling launch sites in, 58–61  
 control of, 48  
 counterinsurgency operations in, 36  
 Gold Wall around, 76  
 medical engagements in, 91  
 rebuilding of, 80, 90  
 U.S. presence in, 94
- Hammond, Jeffery, 4  
 and active patrol of launch sites, 58  
 on AQI neutralization, 17–18  
 on capability of Iraqi Army, 68  
 and isolation of Sadr City, 13  
 on popular view of JAM, 14  
 and rebuilding efforts, 80  
 on reconstruction, 90  
 on second cease-fire, 81  
 on securing of Route Gold, 67  
 on strike on key leaders, 80
- Hatcher, Robert  
 as BSB commander, 34  
 and manpower pressures on BSB, 63–64  
 on training, 34
- heavy armored forces, in urban combat, 108–109
- Hezbollah Brigades, 86  
 IRAM attacks by, 86–88  
 neutralization of, 89
- high-technology resources  
 enabling urban combat, 106–107  
 against JAM rocket attacks, 3, 48–58  
 journalistic attention to, 1, 2  
*See also* aerial ISR and strikes
- Hort, John  
 and active patrol of launch sites, 58  
 and aerial strikes, 57  
 and augmentation of TF 1-68 CAB, 61  
 at Iraqi District Advisory Council, 86, 87  
 ISR for, 50  
 and monitoring of UAS feeds, 54

- and Operation Gold Wall, 72
- Petraeus' guidance for, 53
- on reconstruction, 90
- on snipers, 25
- on strike operations, 57
- on Stryker vehicles, 61
- on success of Battle, 101–102
- on TF 1-6 IN, 78
- on training, 34
- human terrain, on eve of Battle, 19–23
- Hussein, Qusay, 116
- Hussein, Saddam, 26, 97n1, 102
- Husseiniya
  - contained offensive in, 47
  - JAM presence in, 35
  - uprising in, 44
- Imam Ali Hospital, 80
- improvised explosive devices (IEDs)
  - disarming, 37
  - of Hezbollah Brigades, 86
  - intelligence on, 27
  - and launch site control efforts, 60
  - Operation Gold Wall procedures for coping with, 73
  - training in spotting, 34
- improvised rocket assisted mortars (IRAMs), 86–88
- Independent Commission on the Security Forces of Iraq, 27, 28
- indigenous security force capabilities, in urban combat, 109–110
- information operations effort, 4
  - as factor in outcome, 99
  - focused on insurgent leaders, 79
  - lack of experience with, 103
  - of MND-B, 89
  - in regaining control of Baghdad, 11–12
- initial operations, 39–69
  - aerial ISR and strikes against rocket attacks, 48–58
  - Iraqi Army securing of Route Gold, 64–68
  - JAM's initial onslaught, 39–41
  - launch site control through active patrolling, 58–61
  - launch site seizures south of Route Gold, 61–64
  - Route Gold as limit of advance, 47–48
  - U.S.-Iraqi stopping of JAM, 41–47
- Institute for the Study of War, 2
- insurgent nodes, after surge, 11
- intelligence
  - after October 2007, 19
  - decentralization of responsibility for, 85
  - exploiting, 11
  - to identify/locate insurgent leaders, 11, 100
  - on key leaders, 79, 80
  - received during reconstruction, 83, 84, 93–94
  - from Sadr City inhabitants, 27, 93–94
  - intelligence, surveillance, and reconnaissance (ISR), 106–107.
    - See also* aerial ISR and strikes
  - International Zone, JAM rocket attacks on, 26
  - Iran, Special Groups support from, 25
  - Iraqi Army
    - under Baghdad Security Plan, 8
    - capabilities on eve of Battle, 27, 28, 68
    - and checkpoint attacks, 44
    - competence of, 3
    - development of, 97–98, 101, 103
    - intelligence gathered by, 84
    - and order to occupy Sadr City, 81
    - and securing of Route Gold, 64–68
  - Iraqi District Advisory Council, 86, 87
  - Iraqi government
    - assumption of security/essential services responsibility by, 93
    - Basra offensive by, 17, 39, 97
    - control of Sadr City by, 97
    - JAM confrontation with, 19
    - and JAM's initial attack, 40
    - and reconstruction efforts, 3, 93
    - and Sadrist militias, 18
    - tension between JAM and, 18
    - and U.S. access to Sadr City, 12, 71
  - Iraqi perspective on battle, sources of, 2, 115–116
  - Iraqi security forces (ISF)
    - under Baghdad Security Plan, 8
    - development of, 94–95
    - divided loyalties of, 29
    - on eve of Battle, 27–29
    - and JAM's initial attack, 40, 41, 44, 47
    - qualified success of, 99
    - shaking out of, 3
    - in stabilizing Sadr City, 13
    - See also* Iraqi Army; National Police
  - Ishbilyah district, 20–21
    - controlling launch sites in, 58–61
    - control of, 48
    - counterinsurgency operations in, 36
    - Gold Wall around, 76
    - medical engagements in, 91
    - rebuilding of, 80, 90
    - U.S. presence in, 94

- Islamic Supreme Council of Iraq (ISCI), 19, 93  
 isolating insurgents, 108  
 isolating Sadr City, 13–14
- Jaish al-Mahdi (JAM), 1  
 al-Maliki government support withdrawn by, 19  
 and al-Sadr's call for cease-fire, 61  
 in Basra, 19  
 dominance in Sadr City by, 12, 15  
 and electricity problems, 92, 93  
 on eve of Battle, 23–27  
 and Gold Wall, 3  
 and impending Basra attacks, 39  
 initial onslaught by, 39–41  
 intelligence on, 12  
 and Iraqi Army, 3, 98, 101  
 and isolation of Sadr City, 13–14  
 logs of attacks by, 115  
 maintaining pressure on, 85–89  
 military capacity of, 96, 108  
 military vulnerabilities of, 102  
 miscalculation by, 102  
 MND-B's targeting of key leaders, 78–81  
 mosque destroyed by, 59  
 and NAI 608 seizure, 63  
 operational concepts used against, 7  
 in Operation Gold Wall, 71–78  
 options for neutralizing, 17  
 and politics of battle, 102  
 popular support for, 17, 26–27  
 reprisals against informants, 94  
 as source of insecurity, 106  
 Special Groups of, 25–26  
 standoff between 3-4 BCT and, 35  
 success of Gold Wall against, 10  
 U.S. information on, 100  
 U.S.-Iraqi initial stopping of, 41–47  
 weaknesses of, 26
- Jamiliyah Market, 20  
 JAM's income from, 74  
 reestablishing, 90  
 sewage cleanup at, 91
- Jamiliyah Square, 66
- Joint Direct Attack Munitions, 107
- Joint Maneuver Readiness Center, Hohenfels, Germany, 78
- Joint Special Operations Command (JSOC)  
 operations, 36
- Jones, James, 27
- JSS Ur, 86
- Keller, Chris  
 on active patrol of launch sites, 59  
 on Camp Victory attack, 40  
 and checkpoint attack, 42, 43
- launch sites  
 active patrolling to control, 58–61  
 inhibited by reconstruction, 90  
 limiting JAM's access to, 72 (*See also* Operation Gold Wall)  
 seizures south of Route Gold, 61–64  
 successful efforts against, 99
- leaders (insurgent)  
 engagement of, 89  
 strikes against, 78–81  
 targeting of, 85–86, 100–101
- League of the People of Truth, 115
- Lewis, Steve, 41
- “Lieutenant Colonel Y,” 64, 67
- lob bombs, 86
- Looney, Todd  
 and checkpoint attacks, 44  
 and Operation Gold Wall, 73  
 on training, 33, 37
- Mao Zedong, 101, 108
- medical engagements, 91
- Messmer, Gerry, 80
- methodology of study, 4–5
- microgeneration, 90
- microgrants, 90–91
- minimum force, 53
- mobility of insurgents, 108
- Morse, Kyle  
 and active patrol of launch sites, 59–60  
 on JAM's tactics, 41
- Multi-National Corps–Iraq (MNC-I)  
 in chain of command, 32  
 in initial concept of operations, 48  
 and ISR capabilities, 48  
 Stryker brigades used by, 31
- Multi-National Division–Baghdad (MND-B)  
 1st Calvary Division as, 3, 7  
 3-4 BCT as, 3  
 AQI neutralization by, 17–18  
 attacks on key adversary leaders, 78–81  
 in chain of command, 32  
 disposition of brigades, 30  
 on eve of Battle, 39  
 information operations campaign of, 89  
 in initial concept of operations, 48  
 and launch site control, 99

- multidimensional onslaught by, 4
  - organization under, 84–85
  - reconstruction effort of, 3, 84, 89–90
  - and Route Gold limit on advance, 47–48
- Multi-National Force–Iraq (MNF-I)
  - in chain of command, 32
  - COIN Academy of, 35
- named area of interest (NAI) 608 seizure, 63
- National Police
  - under Baghdad Security Plan, 8
  - corruption of, 29
  - development of, 94–95
  - and JAM’s initial attack, 40, 41
  - and Shaab uprising, 45
- North, Brian
  - and capability of Iraqi Army, 68
  - and securing of Route Gold, 66
- Northrop, Jason
  - on amount of intelligence, 27
  - and checkpoint attack, 43–44
  - on COIN Academy, 35
  - and JAM’s initial attack, 46
  - on launch site ambushes, 59
  - on police corruption, 29
  - on UASs and air weapons teams, 51
  - and vehicle use, 37
- Oksenvaag, Erik, 78
- Operational Environment (OE) Gold, 21, 78, 84, 90
- Operation Charge of the Companions of al-Sadr, 115
- Operation Charge of the Knights, 47, 115
- Operation Gold Wall, 71–82
  - building efforts, 73–78
  - decision to build wall, 71–73
  - and focus on key leader attacks, 78–81
  - and rebuilding efforts, 80
  - success of, 101
- Operation Striker Denial, 48, 49
- outcome assessment, 97–104
  - Iraqi Army development, 97–98
  - Iraqi government control of Sadr City, 97
  - long-term significance, 98–99
  - reasons for coalition prevailing, 99–103
- Pappal, Mike
  - and active patrol of launch sites, 58–59
  - on JAM’s capabilities, 41
  - on National Police, 45
  - and Operation Gold Wall, 73
  - on rules of engagement, 53
  - and Shaab attacks, 46–47
  - on standoff between JAM and 3-4 BCT, 35
  - as TF 1-68 CAB commander, 30
  - on training, 31, 34
- Pemrick, Mike
  - Iraqi Army at checkpoints, 44
  - and securing of Route Gold, 67
  - and success of Battle, 101–102
- Petraeus, David H., 53
- physical terrain, on eve of Battle, 19–23
- political context, on eve of Battle, 17–19
- population, protection of, 106
- Predator UAS, 48–50, 54
- provincial elections, 95–96, 98–99
- Rainey, Jim
  - on cessation of Green Zone rocket attacks, 57
  - on launch sites, 99
- reconstruction, 3, 4
  - exploiting success through, 83, 89–94
  - in Ishbiliyah and Habbibiyah, 80
  - local intelligence during, 83
  - purpose of, 83
  - success of, 101
- rocket attacks
  - JAM’s initial attack on Green Zone, 40, 41, 46, 57–58, 61
  - neutralized with aerial ISR and strike assets, 48–58
  - See also* launch sites
- Rosenberg, Mark, 67, 101
- Route Bama, 81
- Route Gold (Al-Quds Street), 47
  - and active patrol of launch sites, 59
  - building wall along (*see* Operation Gold Wall)
  - Iraqi Army attacks to secure, 64–68
  - as limit of advance, 47–48, 100, 106
- Route Grizzlies wall, 86
- rules of engagement, 53
- Russian Federation, 110
- Sadr City
  - 2-82 BCT during surge in, 8
  - conditions prior to battle in, 17
  - current low-level violence in, 98
  - Iraqi Army’s occupation of, 81
  - isolating, 13–14
  - JAM’s dominance in, 12, 15
  - JAM sectors of, 24
  - physical and human terrain of, 19–23

- violence in, 18–19
- walls around, 86
- Sadrist movement
  - al-Maliki's rupture with, 18
  - crisis of legitimacy for, 102
  - erosion of popular support for, 1
  - name of, 115
  - See also* Jaish al-Mahdi (JAM)
- Sadrists
  - ISF infiltration by, 29
  - perception management by, 102
  - qualified success over, 99
- Sadrist Trend, 23, 74, 93, 103
- Samaad, Dr., 93
- Sawlat Al al-Sadr, 115
- Sawlat al-Fursan, 115
- Secure Internet Protocol Router Network (SIPRNet), 11, 107
- security, responsibility for, 93
- Shaab
  - JAM presence in, 35, 47
  - uprising in, 44–47
- Shaama, Hassan, 86, 87
- Shadow UAS, 48–50, 54
- Shia extremism, methods used against, 12
- Shia factions, rivalry among, 93
- Shia insurgent networks, 1
- Shia militias, 17
- 60 Minutes*, 2
- Slack, Drew, 78
- small-unit initiative, 107
- snipers
  - in Operation Gold Wall, 75
  - surveillance by, 85, 109
  - in urban combat, 109
- sniper training, for Virginia National Guard, 34
- social entrepreneurship, 92, 101
- Some Principles of Maritime Strategy* (Corbett), 112–113
- Sons of Iraq, 45
- Special Groups (JAM), 25–26
- special operations forces (SOF)
  - JAM leader defeats by, 18
  - in raids on JAM, 12
  - in urban combat, 109
- State of Law coalition, 98, 99
- Status of Forces Agreement, 64–65, 89
- Stover, Steve, 79
- strategic context, on eve of Battle, 17–19
- streets (in Sadr City), 20
- Stryker platoons
  - and checkpoint attack, 41–43
  - in launch site control, 60–61
  - recovery of destroyed Stryker, 60
  - route clearance by, 38
- Subak Sur uprising, 44
- success, consolidating, 83.
  - See also* exploiting success
- Sunni insurgency, neutralization of, 17
- “surge” in Iraq, 7
  - 2-82 BCT during, 8–10
  - regaining control of Baghdad after, 10–13
- Taji, Camp, 8
- Talley, Jeff, 91–94, 101
- Task Force 1st Battalion, 6th Infantry Regiment (TF 1-6 IN), 33–34
  - COIN operations by, 85
  - counterterrorism judge used by, 89
  - insurgent infrastructure targeted by, 84
  - and microgrants, 91
  - in Operation Gold Wall, 78
  - preparation of, 103
  - Route Grizzlies wall by, 86
  - transitions by, 110
- Team C, 1st Battalion, 64th Armored Regiment, 61
- technology. *See* high-technology resources
- Thompson, Kurt
  - on assets assisting TF 1-6, 85
  - in Operation Gold Wall, 78
  - on reconstruction and launch sites, 90
  - on snipers' contributions, 85
- training
  - COIN Academy's challenge of assumptions in, 35–37
  - for JAM Special Groups, 25
  - pre-deployment, 30–35
  - of TF 1-6 IN, 78
- Trainor, Bernard, 2
- transitions by forces, 110
- trash removal, 93
- unmanned aerial systems (UASs), 1
  - against JAM rocket attacks, 48–56
  - monitoring feeds from, 54
  - in Operation Gold Wall, 73, 74
  - See also* aerial ISR and strikes
- urban combat, 105–113
  - decision making in, 107
  - ground maneuver in, 108
  - heavy armored forces in, 108–109
  - high-technology capabilities in, 106–107

- indigenous security force capabilities in, 109–110
- integrating special operations forces in, 109
- mobility of insurgents in, 108
- protecting population in, 106
- snipers in, 109
- transitions by forces in, 110
- as wide-area security missions, 110–112
- U.S. forces
  - under Baghdad Security Plan, 8
  - control of Sadr City in 2004, 26
  - on eve of Battle, 29–30
  - preparation of, 103
  - shift in emphasis for, 110
- Victory, Camp, 40
- Virginia National Guard, 34
- White, Pat, 33
- wide-area security missions, urban combat as, 110–112
- Zimmerman, Frank, 79

In late March 2008, a Shi'a uprising in Baghdad's Sadr City district challenged the authority of the Government of Iraq (GoI) at its heart. The Jaish al Mahdi (JAM) overran GoI outposts in the district and barraged the International Zone with short-range rockets. The eruption of violence threatened to draw U.S. forces into a battle in a closely packed urban area inhabited by an estimated 2.4 million people, many of whom strongly supported the GoI's main antagonist, Moqtada al-Sadr. U.S. casualties and collateral damage could have been substantial. Instead, through innovative tactics combining high-technology airborne surveillance and strike, elements of siege warfare and vigorous exploitation through civil military operations, coalition forces managed to subdue the uprising with minimum loss to U.S. forces and the civilian population. Success in this battle solidified Iraqi government control over all of Baghdad and throughout Iraq, creating conditions that enabled the United States to realize contemporary operational objectives in Iraq. The authors present the first full operational analysis of the battle and distill insights and lessons that can inform a broader understanding of urban operations, particularly those conducted as part of irregular warfare. This new paradigm can help the Army focus on what capabilities it will need in the future for such operations.



[www.rand.org](http://www.rand.org)

\$37.50

ISBN 978-0-8330-8028-8  
5 3 7 5 0

